



ISAF INTERNATIONAL UMPIRES' AND MATCH RACING MANUAL

December 2012

PREFACE

The Manual before you is a state-of-the art description of today's umpiring skills and techniques.

The manual is a learning tool for umpires starting their training while working towards qualification as IU, as well as for qualified IU's who want to keep their knowledge and techniques up to date and use this manual as a reference document.

A willingness to learn and the relentless pursuit of consistent performance have proven to be the two key characteristics of today's successful umpire at any level. It is in the spirit of these two attributes that this manual has been written.

The writing of this manual was originally co-ordinated by Marianne Middelthon. Her task was a considerable one, and all umpires should be grateful for this effort. In the work, she has drawn on her colleagues' experience and on their willingness to be involved in the project by writing sections, providing comments and suggestions, etc. Thus it is a team effort, and the International Umpires' Subcommittee sincerely wants to thank Marianne and her team for devoting so much of their time to the project.

This version and the previous one have not involved a complete restructuring, but editing and keeping it up to date with current umpiring techniques and rule revisions is still a considerable task. The aim is to undertake a significant restructuring and rewrite in the near future.

This manual cannot be perfect. Match racing, and with it umpiring, is a developing sport, which introduces new concepts, better techniques, etc. all the time. That is why this manual needs to be a living document that is upgraded regularly. Of course, this can only be done if umpires around the world write in with their comments and suggestions. Please contact the ISAF Office if you would like to contribute to the continuous improvement of this manual and the development of the umpires' role in the sport.

Jan Stage
Chairman, International Umpires Sub-Committee

CONTENTS	Page
Preface	i
Usage	ii

ISAF RACE OFFICIALS MANUALS COMMON SECTIONS

Section 1 – The Court of Arbitration for Sport (CAS)

1.1	Introduction	1 / 2
1.2	Jurisdiction, Documents and Rules	1 / 2
1.3	CAS Hearings	1 / 2
1.4	ISAF Contact if involved in a CAS Hearing	1 / 3

Section 2 – Support Persons At Regattas

2.1	Introduction	2 / 2
2.2	Definition of Support Persons, Coaches, Team leaders, Parents and Others	2 / 2
2.2.1	Relationship with Support Persons	2 / 3
2.2.2	Professional Coaches	2 / 3
2.2.3	Parents as Supporters	2 / 4
2.2.4	Other Support Persons	2 / 4
2.3	Regatta Services to Competitors	2 / 4
2.4	Initial and Daily Briefings for Competitors and Support Persons	2 / 5
2.4.1	Other Communications During the Regatta	2 / 6
2.5	Support Boats on the Water	2 / 7
2.6	Establishing Exclusion Zones on the Water	2 / 8
2.6.1	Safety Plans Involving Support Boats Afloat	2 / 9
2.6.2	Communication with Support Persons on the Water	2 / 10
2.7	Judges' Debriefing on Rule 42 Penalties	2 / 10
2.7.1	Umpires Communications to Competitors	2 / 10
2.8	When Things Go Wrong	2 / 11
2.8.1	Procedures to Investigate and Penalise under the Rules	2 / 11
2.8.2	Incidents Involving Parents and Other Support Persons	2 / 12
2.9	Allegations of Physical or Sexual Abuse of a Youth by a Coach, Parent or Support Person	2 / 12

Section 3 - Crisis Management

3.1	Objectives	3 / 2
3.2	Introduction	3 / 2
3.3	Risk Assessment and Crisis Management Plan	3 / 2
3.4	Influence of Event Types on Safety Provision	3 / 3
3.5	Responsibilities	3 / 3
3.5.1	Competitors	3 / 3
3.5.2	Race Officer	3 / 3
3.6	Outline Structure of Safety Plan	3 / 4
3.6.1	Dinghy and Board Events	3 / 4
3.6.2	Ocean, Offshore and Yacht Racing Events	3 / 8

Section 4 - Race Officials and Junior Sailors

4.1	Introduction	4 / 2
4.2	Definition of Junior Sailors	4 / 2

4.3	Race Officials Role at Junior Regattas	4 /3
4.4	Visibility	4 /3
4.5	Communication With Sailors and Their Coaches	4 /4
4.6	Protests	4 /4
4.7	Observers	4 /4
4.8	Use of the Protest Flag	4 /5
4.9	Reporting to the Race Committee At The Finish	4 /5
4.10	Arbitration	4 /5
4.11	Rule 42 and Appendix P	4 /5
4.12	Regatta Briefings	4 /6
4.13	Parents, Coaches and Club Support	4 /7
4.14	Support Boats	4 /7
4.15	Rule 69 Gross Misconduct	4 /7
4.16	Sailor's Ethics	4 /8
4.17	Legal Obligations of Child Protection	4 /8
4.18	Outside Assistance	4 /9
4.19	ISAF Introductory Rules of Racing	4 /9
4.20	Sailing Instructions	4 /9

Section 5 – Handling Misconduct

5.1	Introduction	5 /2
5.2	When should rule 69 be used	5 /2
5.3	Who is subject to rule 69.1	5 /2
5.4	Types of behaviour justifying a rule 69 hearing	5 /3
5.5	Who may make a report	5 /3
5.6	Form of Report	5 /3
5.7	Who should the report be lodged to	5 /3
5.8	Reports lodged with organizing authorities/clubs/other authorities	5 /4
Appendix A – Examples of Gross Misconduct		5 /5

Section 6 – Guidelines for Dealing with the Media

6.1	Introduction	6 /2
6.2	Definition	6 /2
6.3	ISAF's Approach to the Media	6 /2
6.4	What to do and what not to do when talking to the media	6 /2
6.4.1	Do	6 /3
6.4.2	Do not	6 /4
6.4.3	Understanding how Journalists Work	6 /4
6.4.4	Keeping a record of press contacts	6 /5

ISAF UMPIRES' AND MATCH RACING MANUAL SECTIONS

A Introduction

A.1	The development of umpiring	A 2
A.2	The purpose of this Manual	A 2
A.3	Contents of this Manual	A 3

B The Fundamentals of Match Race Umpiring

B.1	Objective	B 2
B.2	Initiation of 'Protest'	B 2
B.3	Decisions	B 2
B.4	On the Water Penalties	B 3
B.5	Techniques	B 5

B.6	Umpire skills and qualifications	B 6
B.7	Discussion	B 6
B.8	The Call Book for Match Racing	B 6

C Appendix C – Match Racing Rules

D Mechanics of Umpiring

D 1	Preparation	D 2
D 2	The Chief Umpire	D 2
D 3	Initial Umpire Team Meeting	D 3
D 4	Umpires Meeting with Race Committee	D 3
D 5	Umpires Meeting with Competitors	D 3
D 6	Post-Race Debriefings	D 4
D 7	Driving the Umpire Boat	D 5
D 8	Radio Communication	D 6
D 9	Using a Radio	D 6
D 10	Umpire Equipment	D 7
D 11	Umpire Interaction	D 7
D 12	Umpires' Instantaneous Calls	D 12
D 13	Wing Umpires	D 13
D 14	On-Board Observers	D 13
D 15	Penalty Signals	D 14
D 16	Umpire More Consistently	D 16
D 17	Signalling	D 17
D 18	Umpire and Wing Boat Etiquette, Positioning	D 18
D 19	Visitors on Umpire Boats	D 19
D 20	Red-flag Protests	D 19
D 21	Umpiring Team Assignments	D 20
D 22	On-Shore Duties	D 21
D 23	Incident Report Forms	D 22
D 24	Explaining Decisions to Competitors	D 22
D 25	One on One communications with competitors or rules advisors	D 23
D 26	Explaining Decisions to the Public	D 23
D 27	Press Conferences and Individual Meetings with the Press	D 23
	Briefing Check Lists - Umpire & Jury Team	D 25
	Briefing Check Lists - Umpire/Race Committee	D 27
	Umpiring Team Assignments	D 29
	Match Racing Incident Report Form 1	D 30
	Match Racing Incident Report Form 2	D 31
	Match Racing Protests	D 32

E Umpiring Scenarios

E 1	Position at the Preparatory Signal, First Cross	E 2
E 2	Entering the Pre-Start Area	E 2
E 3	Close-Hauled, Particularly after Tacking	E 2
E 4	Tacking and Gybing	E 3
E 5	Head to Wind	E 3
E 6	Room to Keep Clear	E 3
E 7	Fish-tail	E 4
E 8	Approaching the Starting Marks	E 4
E 9	Close Tacking	E 4
E 10	Slam Dunk	E 4
E 11	Dial down	E 4

E 12	Proper Course	E 5
E 13	Sailing above Proper Course Downwind	E 5
E 14	Overlaps	E 6
E 15	Marks - Room at Marks – Mark-Room	E 6
E 16	Touching a Mark	E 8
E 17	Passing Obstructions	E 9
E 18	Room at Continuing Obstructions	E 9
E 19	Illegal Propulsion	E 10
E 20	Finishing Line Incidents	E 11
E 21	Damage from Contact	E 11
E 22	Incidents with a Boat in Another Match	E 12
E 23	Arm Signals	E 12
E 24	Gaining an Advantage	E 13
E 25	Deliberately Breaking a Rule	E 13
E 26	Gaining a Controlling Position – Red-Flag Penalties	E 13
E 27	Good Sportsmanship	E 14
E 28	Other Umpire-Initiated Penalties	E 14
E 29	Y-Flag Displays	E 14
E 30	Taking Penalties	E 14
E 31	Incorrect Penalties	E 15
E 32	Wing Boat Signals	E 15
	7 questions about approaching obstructions in the pre-start	E 16
	Notes to Umpires about Damage Procedures	E 21
F	Umpire Positioning	
F 1	As Boats Enter	F 2
F 2	During the Pre-Start Manoeuvres	F 2
F 3	Pre-Start Same Tack	F 3
F 4	Turning Back	F 3
F 5	Approaching the line to start	F 4
F 6	At the Starting Signal	F 4
F 7	Windward Legs	F 4
F 8	Port and Starboard Crossings	F 5
F 9	Slam Dunk	F 6
F 10	Lee-Bow Tacks	F 7
F 11	Downwind Legs	F 7
F 12	The Forbidden V's	F 9
F 13	Rounding Marks	F 9
F 14	The zone	F 12
F 15	Touching Marks	F 12
F 16	Seven Scenarios for the First Cross	F 13
G	Wing Umpire and Observers	
G.1	Wing Calls and Positioning	G 2
G.2	Wing Umpire - Unsighted	G 3
G.3	Wing Umpire – Overlap Calls	G 3
G.4	Wing Umpire – Distance Calls	G 5
G.5	Reduced Number of Wing Umpire	G 7
G.5	Observers	G 9
H	Race Management	
H.1	Introduction	H 2
H.2	Required Personnel	H 3

H.3	Course	H 4
H.4	Starting Lines	H 8
H.5	Starting Procedures	H 9
H.6	Course Changes	H 11
H.7	Finishing	H 12
H.8	Scoring	H 12
H.9	Race Committee and Umpires Equipment	H 13
	Sample Starting Sequence	H 14
	Sample Score Sheet	H 15
	Sample Damage Report Form	H 16
I	Reserved for future use	
J	Suggested Umpire and Race Committee Equipment	
J.1	Competitor Boats	J 2
J.2	Umpire Flags	J 2
J.3	Penalty Shapes and Flags	J 2
J.4	RC Signal Boat Flags	J 3
J.5	Umpires Equipment	J 3
J.6	Marks	J 3
J.7	Umpire Boats	J 3
J.8	Spares	J 3
	Supplement for Flags v Shapes	J 4
K	ISAF Standard Match Racing Notice of Race	
L	ISAF Standard Match Racing Sailing Instructions	
M	Competition Schedules or ‘Pairing Lists’	
M.1	Recommended Criteria for Dividing Competitors into Groups (or Pools)	M 2
M 2	Recommended Criteria for Round Robin Pairing Lists	M 2
M.3	Discussion on Competition Format	M 3
M.4	Some Examples of Pairing Lists	M 6
M.5	SI for 12 Skippers 6 Boats – short Round Robin	M 11
M.6	Tie Break Sail Offs	M 13
N	Umpires Programme	
N.1	The Origin of the Umpires Programme	N 2
N.2	The Goals of the Programme	N 2
N.3	How to Achieve These Goals	N 3
N.4	Performance Assessment	N 3
N.5	The Grouping System	N 4
N.6	How to Contribute to the Umpires Programme	N 4
N.7	International Umpires Sub-committee	N 5
N.8	International Umpires Administration	N 5
	ISAF Umpire Performance Assessment Form	N 6
O	Reserved for future use	
P	List of Forms	
P.1	International Umpires Sub-committee Forms	P 2
P.2	Match Racing Committee Forms	P 2
Q		
Q.1	Addendum Q – Umpired Medal Race Rules	Q 2



ISAF RACE OFFICIALS MANUALS

COMMON SECTIONS



ISAF RACE OFFICIALS MANUALS

COMMON SECTIONS

SECTION 1

The Court of Arbitration for Sport (CAS)

Contents		Page
1.1	Introduction	1 / 2
1.2	Jurisdiction, Documents and Rules	1 / 2
1.3	CAS Hearings	1 / 2
1.4	ISAF Contact if involved in a CAS Hearing	1 / 3

1.1. Introduction

The Court of Arbitration for Sport (CAS) is an international arbitration body set up to settle disputes related to sport.

In recent years there have been several sailing related matters that have been determined by CAS.

It is important to recognise that there are limited matters where CAS will have jurisdiction.

In order for a dispute to be submitted to CAS, there must be an arbitration agreement between the parties which specifies recourse to CAS. ISAF have invoked the jurisdiction of CAS in limited circumstances and reference is made to those in the ISAF Regulations, e.g., anti-doping.

Parties may by agreement refer a matter to CAS for resolution as it is an arbitration body.

1.2. Jurisdiction, Documents and Rules

Jurisdiction is also conferred in respect of any dispute arising on the occasion of, or in connection with, the Olympic Games by virtue of Article 59 of the Olympic Charter and this provides that such disputes must be submitted exclusively to CAS.

It should be noted that this does not refer just to the occasion of the Olympic Games but to any dispute arising “in connection with” the Olympic Games.

CAS has rules regarding lodgement of documents and it is common for lawyers to appear for parties in such matters.

CAS panels are made up of lawyers and judges who are experienced in dealing with sport matters but may not necessarily be familiar with sailing. Accordingly, it is important to ensure that a full explanation of matters is put into the documentation to be lodged with CAS explaining the position of the party prior to the hearing. This will include the ISAF Rule Book and quite likely the Notice of Race and Sailing Instructions and an explanation of the circumstances giving rise to the decision being appealed.

It is important to recognise that CAS has jurisdiction to overrule the Rules of sports federations and their protest committees if they find that decision making bodies have conducted themselves with a lack of good faith or not in accordance with due process. Appeals will usually be lodged with CAS in relation to:

- Field of Play matters;
- Matters relating to a protest hearing.

1.3. CAS Hearings

In relation to hearings CAS’s focus will usually be on procedural fairness and to ensure that the Protest Panel has applied their Rules and not acted with bias or otherwise in bad faith.

As a general principle, CAS will not interfere with decisions made on the “field of play”. The reason for this is that such a body will not generally review decisions of judges and umpires who are well-placed to decide such matters on the field of play and such matters are usually of a technical/specialised nature.

This approach however is always tempered by the requirement that such decisions must not be taken in violation of the rules of the sport and law or such decisions made in bad faith, e.g., as a consequence of corruption, nationality bias or something similar. In summary, CAS does not have the function of reviewing technical matters and CAS will only interfere if an official's field of play decision is tainted by fraud or arbitrariness or corruption.

Some instructions commonly include penalties which can be less than disqualification. Experience has shown that it is important for a Jury to have in place, prior to the event, a document that gives guidance to the Jury as to the criteria to be applied in determining an appropriate penalty in such case. Such documentation and a demonstration as to how the Jury applied such criteria would be very useful in such a case.

Experience has shown that CAS is supportive of decisions made by Race Officials provided the above is followed.

1.4. ISAF Contact If Involved In A CAS Hearing

As CAS matters can be complicated, Race Officials involved in a CAS Appeal should immediately advise the ISAF Secretary General. It is also quite possible that ISAF will be a party to any such proceedings.



ISAF RACE OFFICIALS MANUAL

COMMON SECTION 2

Support Persons at Regattas

Contents	Page
2.1 Introduction	2 /2
2.2 Definition of Support Persons, Coaches, Team leaders, Parents and Others	2 /2
2.2.1 Relationship with Support Persons	2 /3
2.2.2 Professional Coaches	2 /3
2.2.3 Parents as Supporters	2 /4
2.2.4 Other Support Persons	2 /4
2.3 Regatta Services to Competitors	2 /4
2.4 Initial and Daily Briefings for Competitors and Support Persons	2 /5
2.4.1 Other Communications During the Regatta	2 /7
2.5 Support Boats on the Water	2 /8
2.6 Establishing Exclusion Zones on the Water	2 /8
2.6.1 Safety Plans Involving Support Boats Afloat	2 /9
2.6.2 Communication with Support Persons on the Water	2 /10
2.7 Judges' Debriefing on Rule 42 Penalties	2 /10
2.7.1 Umpires Communications to Competitors	2 /10
2.8 When Things Go Wrong	2 /11
2.8.1 Procedures to Investigate and Penalise under the <i>Rules</i>	2 /11
2.8.2 Incidents Involving Parents and Other Support Persons	2 /12
2.9 Allegations of Physical or Sexual Abuse of a Youth by a Coach, Parent or Support Person	2 /12

2.1 Introduction

This Section addresses interaction with coaches, parents and other support personnel at regattas and how to handle problems that may arise. Interactions involve arrangements, communications, and access to the proceedings of the regatta, e.g. briefings and protest hearings. Interaction also includes working through a problem when something goes wrong.

2.2 Definition of support persons: Coaches, Team Leaders, Parents and Others

Competitors often come to regattas with Coaches, Team Leaders, Parents or other persons who support them. They provide physical or advisory support to a competitor, including the gathering of data that may be used at a later time. In this section we use the term, “support persons” to include all such individuals.

Support persons are an important part of regattas, taking an active role in getting the competitors to and from, and supporting them throughout the regatta. This will vary, depending on the type of event and the age of the competitors. They will accompany the competitors to events, seeking admission to the venue and, where allowed, accreditation to enter restricted areas, requesting the use of launch facilities and mooring spaces for their powerboats and participate in the social activities. The role they play with their competitors is important to the competitors’ success and will normally involve interaction with officials on behalf of their competitors but it is preferable that their discussions/submissions should be with the competitor(s) they are registered with.

Depending on the standard of the competitors, e.g. national teams, competitors may also have support personnel, such as weather experts, rules experts, and others who do not travel to the venue. Where it has been set up prior to the regatta it is helpful to these persons to have information, such as notices posted on the Official Notice Board, protests listed for hearing and decisions, and other information published simultaneously on the event web site. It is not always possible to have simultaneous web postings and this is dependent on the sophistication of the event web site and the funds available to have such a web site. Currently there is no *standard* style of web site to provide this. These web postings make information directly available to off-site support personnel for their benefit and associated competitors.

It is useful for race officials to know who the support personnel at regattas are, which competitors they are associated with and the role they are playing. It is also important for race officials to understand the relationships between competitors and their support personnel.

At some regattas, competitors or teams are selected and entered by their Member National authority or sailing club. These MNAs or clubs often appoint their own Coaches or Team Leaders. At youth and junior regattas, parents, or other adults often accompany competitors and frequently take responsibility for the wider well-being of the competitors. At other regattas competitors often bring their own Coach or other support personnel. Sometimes these people are shared by several competitors.

2.2.1 Relationship with Support Persons

Support persons often approach officials on behalf of their competitors, or along with competitors, to get information about the schedule and running of the regatta, or to enquire about any penalties or actions taken against their competitors.

It is beneficial to have a working relationship with support persons, just as it is with competitors. An appropriate relationship is where the support persons feel included and respected, and they have respect for the race officials to carry out their role without interference.

The best way to go about establishing an appropriate relationship will depend upon many factors and will vary from regatta to regatta. The variables will include the particular environment, the personality of the race official concerned, and the attitude and level of experience of the support persons to name a few. The more often a race official officiates at that class the stronger the respect becomes between the officials and support people.

Some of the techniques that have served race officials well include:

- Be visible and approachable.
- Be seen around the regatta site and on the water. Be available to talk with support persons, while avoiding the appearance of taking a personal interest in one individual or group. However, where possible, ensure there are two officials walking around the site or at any discussion.
- Being approachable does not mean that you should try to please everybody all the time as, to do so, will only create a situation where you please nobody or, worse still, appear weak and able to be manipulated.
- Be aware of cultural and language differences. What might be considered normal and acceptable behaviour in one culture could be confronting or rude in another. Learning a few words in a foreign language such as “good morning” can go towards establishing a good relationship even if communication is otherwise difficult.

2.2.2 Professional Coaches

Many Coaches are paid professionals. Some have performance contracts, with provisions that their future livelihood depends on the success of the competitors they are coaching. Often coaches and team leaders have as much or more regatta experience than the race officials and can have a unique understanding of any current issues that might arise. Being mindful of these possible circumstances when their competitors are not performing well can be useful background to officials when interacting with Coaches and competitors over specific issues.

Coaches may be qualified as “trained” or “qualified,” having completed suitable qualifications issued by their MNA or in other countries. Training and certification typically includes valuing, interacting, leadership, problem solving, and critical thinking. An important core competency they must demonstrate is making ethical decisions. Further training usually includes qualification to operate a power boat and a VHF radio, as well as First Aid certification, including CPR, swimming and rescue.

Coaches in many countries abide by a Coaches’ Code of Conduct or a Coaches’ Code of Conduct and Ethics. Codes from several national authorities indicate that coaches are expected to adhere to the following ethical standards, amongst others:

- Respect for the rights, dignity and worth of others

- Avoidance of any form of harassment
- Accepting the guidelines and spirit of the rules
- Adherence to the guidelines laid down by their governing bodies
- Promotion of the positive aspects of the sport, and fair play
- Providing a safe environment
- Leading by example
- Integrity
- Safety
- Prohibiting drug and alcohol use

Many Codes include procedures to investigate a breach of the Code and include possible disciplinary action by their MNA based on a report of an alleged breach of the Code.

With their training and ethical principles, Coaches can be valuable partners in the efficient operation of regattas. Coaches can have a calming and steadying influence on their competitors, especially in stressful situations.

2.2.3 Parents as Supporters

Parents frequently accompany youths to regattas, particularly youth events, to serve a similar functions as coaches. Parents are a diverse group of individuals in terms of the training and the experience they bring in supporting competitors at regattas. Whilst some parents are experienced competitors, others have little or no experience and this needs to be kept in mind and are not bound by any Code of Conduct or Ethics. Their main object is to have the safety, well-being and their goals for their children foremost in mind.

Parents normally do not have the same comprehension of appropriate behaviour and attitude that coaches have.

2.2.4 Other Support Persons

Teams, such as national teams, bring other support persons who are not Coaches or parents. These persons are a diverse group of individuals in terms of roles, training and experience. They might serve as chaperones to young competitors or be more closely linked to aspects of meteorology, boat management and sailing. Depending on their experience they might not all have the same understanding of appropriate behaviour and attitude to a regatta. Those who are appointed by a Class or MNA are bound by a Code of Conduct of Ethics.

2.3 Regatta Services To Competitors

The Organizing Authority needs to provide information to competitors to assist them to prepare for the regatta. This information and entry requirements, including entry fee, are normally, these days, communicated through the event website and can include:

Location: Where the regatta will be based and the area where the regatta will be sailed.

Weather and Tides: Average weather during the period of the regatta and tide high and low water and tidal streams as well as the average air and water temperatures.

Travel: Details on travel options to the regatta site, with links to driving instructions, nearby domestic and international airports, railway stations, ferries and visa requirements.

Accommodation: Links or contact information for accommodation or billeting.

Parking: Specify the times before, during, and after the event when parking is available for trailers, vans and campers.

Pre-Regatta Site Access for Competitors and Support Persons: Provide information about any restrictions to the regatta site prior to the event and where launching and parking facilities are available.

On the Water for competitors: Provide information on the entry requirements, entry procedure, entry fees, accreditation process.

Facilities for Support Boats: Launching, Storage, Refuelling and Hauling Out:

Provide information on launching, storage or berthing facilities, refuelling, and haul out facilities for support boats. Requirements for pre-registration and accreditation provides the Organizing Authority with estimates of the numbers of support boats to accommodate on site.

Insurance: Most countries and regattas require competitors and coaches to have third party insurance cover and these limits, including the currency of the policy, should be stated.

Sailing Instructions: Ideally, where possible Sailing Instructions should be available for download from the regatta website at least 3 days prior to the start of the regatta, but a hard copy must always be given to the competitor at registration.

2.4 Initial And Daily Briefings For Competitors And Support Persons

Normally hold a briefing of competitors before the first day of racing. Support persons competitors should also be encouraged to attend. It is also becoming common practice for a daily briefing to be held which provides additional information to competitors and support persons and provides information on what the race committee intend to do on that day. The general tendency these days is that at the subsequent daily meeting Support Persons attend and then pass on the information at the subsequent Team Meeting.

Briefings provide an opportunity to establish communication among the organizers, race officials, competitors and their support people and to introduce the race officials involved with the regatta. A well prepared briefing by officials consolidates the foundation for good communication and is the officials' opportunity to make a good impression and to assure all present that they are knowledgeable, approachable, friendly and sympathetic to the competitors.

The initial briefing provides competitors and their support people with details of the officials they need to approach for help to resolve any problem throughout the regatta.

The briefing for support people leaders would:

- Introduce the key race officials such as the PRO, Measurers, Jury or Umpire Chairman, and Jury/Umpire Team members;
- Identify Race Committee vessels, jury boats and umpire boats;
- Highlight any local harbour navigation rules, hazards and customs;
- Indicate some of the Race Committee's intentions in the event of certain weather conditions, local shipping movements etc.;

- Request that support teams comply with any support boat instructions in the sailing instructions or other documents. This could include the display of national identification on the support boat;
- Provide details of the role of Coach boats in the on-the-water safety plan;
- Remind competitors that sailing is a self policing sport, and of their obligations under “Sportsmanship and the Rules”;
- Advise competitors that they may approach any the members of the measurement team, Race Committee, umpires and jury at any time except when racing is taking place, on or off the water;
- Invite Advise the policy on observers to protest hearings.

Other parts of the Race Officials’ Manuals include other items that could be covered at this briefing.

An appropriate Sailing Instruction wording could be:

Coaches and Team Leaders Meeting

There will be a Coaches and Team Leaders meeting at xxx hours each morning, or 2 hours before the first warning signal of the day if the race schedule is changed to start earlier. The objectives of the meetings are to receive feedback from the coaches on the regatta organization, exchange view points, and inform the coaches about any changes in the sailing instructions and regatta organization in general.

The briefing does not replace the official communications to competitors posted on the official notice board. Competitors who do not have coaches should also attend.

Topics that can be addressed at daily meetings usually include:

Regatta Logistics

- Parking, local community issues, medical services, catering, social events, transport, launching and retrieving, opening and closing ceremonies, notice boards, race office, jury/umpire office locations
- Safety_Management: On-the-water safety covering bad weather, towing of boats, leaving boats unattended and radio channels
- Racing_Logistics: Weather forecasts, course areas, race officer intentions in the event of no wind, or other matters influencing the scheduling of races, staying on shore .
- Equipment: Where boats are supplied by the organising authority, equipment substitution, boat allocation, trash and gear boats on the water
- Drawing attention to any information for competitors published by the jury/umpires, drawing attention to matters of concern, e.g. support boats entering racing exclusion zones, boats who have finished crossing racing areas of boats still racing.
- Feedback: Raising any issues and making suggestions for improvements for this and future events.

These meetings are normally run by the Organizing Authority and include at least the PRO and the Chairman of the Jury or Chief Umpire. It is good practice for all Race Officials to attend these meetings, if possible.

2.4.1 Other Communications during the Regatta

Depending on the nature of the regatta, it is important to make specific provision for recognising, communicating with, and otherwise supporting support persons.

Communication with support persons is made significantly easier and more effective if a relationship has been established. This is even more important at junior regattas where the role of race officials generally, and judges in particular, involve an element of education. Communication with coaches can be quite different from communication with parents, as coaches are not as emotionally involved as a parent.

Officials should not remain detached or aloof. The interaction provides further opportunities for good communication and the development of productive relationships. Be friendly and approachable at all times.

Officials should focus on making themselves visible, accessible, and approachable by the competitors and their support persons. Post a list of key officials (with photographs if possible) on the regatta notice board to make recognition easier.

When officials are ashore and are not required for official duties, they could visit the boat park, in pairs, and converse with competitors and their support persons or go to the main social area for a coffee or snack. It is strongly recommended that more than one official participates in any discussions with competitors to avoid any perception of bias, conflict of interest and various other reasons, particularly when dealing with junior competitors. This is particularly important where a competitor or their support person may have a close connection with an official because of friendship, club affiliation or nationality

Occasionally an informal comment made by a competitor or their support person in the boat park can very useful in identifying a problem or issue that can be resolved before it escalates into a larger issue.

There are times when unofficial discussions with a coach can divert potential problems involving a competitor's behaviour that has not yet reached the stage of a gross breach of sportsmanship.

When competitors wish to speak with an official they should always be told that a support person is welcome to join the conversation. Often the answer to a competitor's question would be helpful for the all competitors to know. In these cases the official should ask for the question to be presented in writing so that they can provide an official written answer to post on the regatta official notice board. There will be times when an official is asked a question that he wishes to consider before answering. These questions are also best presented in writing so that the race official can confer with his colleagues before providing a written answer on the official notice board.

Race Officials performing their primary duty will have the opportunity to monitor competitor's compliance with the rules that apply at the regatta. Examples of such rules may include safety equipment (e.g. wearing buoyancy aid), trash disposal, and class measurement rules. If a competitor is not in compliance, generally a polite comment will coax compliance. Before the beginning of a regatta the officials will have agreed a process for protests brought by the Race Committee, Umpire, Measurers or Protest Committee. This may be to refer the intention to lodge a protest with the PRO or the Protest Committee Chairman, before formally lodging the protest.

2.5 Support Boats On The Water

Many regattas now publish Coach Boat Regulations that apply during the event. For the purpose of these regulations, a coach boat usually includes any boat that is under the control or direction of a person who is providing physical or advisory support to an athlete, including the gathering of data that may be used at a later time. The regulations might also apply to spectator boats if they are linked to competitors.

Coach Boat Regulations typically describe zones on the water where coach boats are allowed while racing is in progress, and describe zones where coach boats may not enter. They might also describe any restrictions on equipment that may be carried on board a coach boat and also provide a procedure for handling an alleged breach of any of these regulations.

The normal method of identifying support boats is to require them to display the national letters of the competitors they are supporting and an identification number supplied by the organisers. The numbers are needed when there is more than one support boat per country. As an example, France quite often sends regional teams to major regattas and there can be numerous French coach boats.

Where there are limited support boats available the Organizing Authority will often require in its Coach Boat regulations that coaches from more than one country share a coach boat.

Not all competitors will have support personnel on the water. The officials should ensure that they do not show favour or bias to any particular boat.

2.6 Establishing Exclusion Zones On The Water

The fairness of the competition, safety, and the facility for race officials to do their jobs requires the control of the positioning and movement of support boats around the race course. Establishing a set of clear and reasonable boundaries for support boats ensures good racing for the competitors.

It is up to classes, or the organising authority, or both, to determine the method of controlling support boats on the water. It then becomes the responsibility of the race officials to manage the positioning and movement of support boats.

“Support people typically want to observe the start then move to the windward mark to observe the mark rounding. In some circumstances, they will know how to watch races without interfering with competitors or the race management and without making excess wake as they proceed to the windward mark, particularly in light weather. Other support personnel with less experience might lack this understanding.

Zones where coach boats may not enter, often called exclusion zones, are specified in the Sailing Instructions and should be supported by a chart of the racing area showing the exclusion zones. They can vary from something as simple as “shall not go within 50 metres of boats racing”, to a much more comprehensive set of rules which could go as far as limiting support boats to a ‘box’ or specify the routes they could take from one end of the course to the other.

Particularly with multi-starts it is becoming more common for the race committee to lay a line of buoys at the side extensions of the start line and below the start line. Support boats are not allowed to be in front of these buoys.

A simple exclusion zone would require support boats to stay:

- about 50 metres behind the start line after the first Preparatory signal for all starts of a race; and
- no closer than 100 metres to the course area bounded by the windward and leeward marks and the lay lines either side or
- within 100 metres of the course a boat may sail.

More sophisticated exclusion zones can address some of these issues could include a 'box' behind the start line and 'lanes' between the top and bottom of the course. Where a trapezoid course is laid the exclusion zone should encompass the entire course areas, even if no boats are racing on the inner or outer loop at any time.

It is also necessary to establish procedures which prevent coaching on the water whilst boats are racing. Such outside assistance is difficult to detect with any certainty and to protest. This type of behaviour is best prevented by protocols, such as establishing exclusion zones on the race course, requiring each support boat to have support people of different nationalities on board, or specifying days when support boats are not permitted on the race course

Always check the class rules for any specific requirements or restrictions on support people who go afloat.

While the race committee is responsible for enforcement of exclusion zones, judges and umpires afloat are often in a better position to monitor support boats. They can carry out the task without waiting for specific requests from the race committee. It is good practice for the race committee, judges and umpires to discuss the preferred approach in advance, and any specific concerns as they arise. Planning will ensure consistency and compliance with the wishes of the organising authority. Observing adherence to the exclusion zones is secondary to the work of monitoring rule 42 under Appendix P, or of umpiring.

Be consistent in the approach to enforcement of these rules. Take care to apply the policy without showing favouritism. The only variation in enforcement would be as a result of differing circumstances that are readily understood. A polite but firm request will achieve the best result.

Should support boats fail to comply with the rules and regulations, the judges and other officials afloat are in a good location to remind the support boat of its obligations. Ask the boat to move back, or give a polite hand gesture.

Should a support boat fail to respond make a note of the country and identification number and post a notice on the notice board, for the coach to meet with the judges at the protest room or with the race officials at the race office, prior to the end of protest time that day.

2.6.1 Safety Plans Involving Support Boats Afloat

Support boats are an important, and sometimes an essential, part of the safety routine at a regatta, enhancing the safety provision at regattas. For safety plans involving support boats to be effective, there must be a commitment from them to assist when requested, an understanding of the circumstances in which such a request might be made, an understanding of 'outside help,' and good communications on the water.

Briefing support people on the safety plan and seeking their full support in the event that they are needed is critical. The safety plan should request support people to commit to provide assistance when asked to do so.

The race committee should hold a safety briefing prior to the first race and seek their assistance and suggestions on improving the plan.

A sailing instruction that restricts the placement and movement of support boats could be:

“Coach” Support Boats

Except when participating in rescue operations, all registered support boats shall be required to stay outside the areas stated in Sailing Instruction xx from the time of the preparatory signal for the first fleet to start, until all boats have finished or retired from that race; or the Race Committee signals a postponement or an abandonment of all fleets. The area where boats are racing is defined in Sailing Instruction yy. Boats are requested to monitor VHF Channel aa¹ which will be used by the race committee to request safety assistance.

Judge and Umpire boats should not tow boats to the course area before racing, even though there is no wind. However, towing boats ashore after racing in response to a request from the Race Committee is acceptable, so long as the Judge or Umpire shows no bias or preference to boats they assist.

2.6.2 Communication with Support Persons on the Water

Where practical, Race Officers should broadcast information of interest to support boats, such as intentions to lower a postponement flag, shifting of a course, and wind speed.

2.7 Judges’ Debriefings On Rule 42 Penalties

When judges are applying Appendix P it is important that competitors and if necessary, support people are aware of why the judges penalized a boat. Judges should be available to discuss the actions that led to the penalty and explain the actions of the competitor and why the penalty was given.

On days with multiple races, the judges should, when practicable, position their boats near the start line for the next race so that competitors and coaches can find them.

On single race days, or after the last race of the day, judges are best approached ashore. When the discussion is held ashore, it is best practice if possible, for the judges who gave the penalty to discuss this with the coach and competitor. If one of the two judges is not available another judge should accompany the available judge. A judge should always have another judge along when talking to competitor.

For further information on debriefings of Appendix P penalties under rule 42, see the International Judges Manual.

2.7.1 Umpires’ Communications to Competitors

Between flights of match races or team races competitors or their support people might approach umpires for an explanation of penalties assigned during the flight. When time permits afloat within the schedule, umpires are encouraged to discuss the penalty to

¹ Not the RC’s own channel but in this day and age, unless a private channel is used, support persons quickly find the channel being used

promote the competitors' understanding of the situation. They would also hold a debriefing ashore.

2.8 When Things Go Wrong

There may be incidents where a support person affiliated with a competitor creates a problem at a regatta. If officials encounter such a situation, it is important to have prior knowledge of the action available to deal with the issue. The course of action to take may differ for coaches or parents, depending on the situation.

The Racing Rules of Sailing provide for hearings involving boats that are alleged to have broken a *rule*, along with provisions for penalties and exoneration. The first step to take when an incident arises is to find out which boat or boats and which competitor or competitors are affiliated with, or supported by the person. The regatta office should have a list of support boats, coaches, and personnel associated with each competitor or team.

The second step is to determine who the person is. Is the person a coach? If so, is he or she is an employee of the MNA, or a club that is a member of the MNA, or is he employed by the competitor or a group of competitors without specific affiliation? Is the person a trained or certified coach from his or her MNA? Even coaches hired by competitors are often certified by their MNA and may be governed by them. There are more processes available for investigating and disciplining a coach than a parent or other support person.

2.8.1 Procedures to investigate and penalize under the rules

If a support person provides outside assistance to a boat that is racing, a boat may protest her for breaking rule 41. The Race Committee or Protest Committee may also file the protest, but not as a result of information arising from a report of an interested party other than the representative of the boat herself. If the protest is upheld, the penalty to the boat would be disqualification in the race or in the race sailed nearest in time to that of the incident under rule 64.1.

Following the introduction of the Racing Rules of Sailing 2013-2016, Rule 69 states that the term 'competitor' is restricted to any boat owner and any crew member and does not extend to include coaches, support personnel or other non-competitors. Therefore the protest committee may not hold a hearing under this rule, nor send a report about that person's actions to the correspondent MNA under rule 69.3.

However, the sailing instructions may include a provision stating that when the protest committee, from its own observation or a report received, believes that a coach or other non-competitor has committed a gross misconduct, including a gross breach of a rule, bad manners or sportsmanship, or conduct bringing the sport into disrepute, it will conduct a hearing following all the requirements of rule 63 and giving the alleged infraction the consideration of a party. If the protest committee decides that the support person has committed the alleged misconduct, it may request withdrawal of accreditation, prohibit access to regatta areas and regatta services, or take other action within its jurisdiction.

If a coach becomes a real problem during an event the PC should to take action, to the benefit of the competitors and the coaches who are complying with the rules. The Protest Committee should call the coach to a meeting and investigate. Then, depending on the seriousness of the offence, the Protest Committee can take different actions, i.e. report

the problem to the OA and ask them, for example, a) to not to allow the coach to enter the club, or b) to remove the coaches' accreditation, or both etc.

The Protest Committee may send a report to the MNA or to ISAF or to both, depending on the event and, if they wish, include a suggested course of action. Since all these actions cannot be taken under rule 69, the MNA is not obliged to follow the procedure stated in rule 69.3.

More detailed information concerning this can be found in Section N of the International Judge's Manual.

2.8.2 Incidents Involving Parents and Other Support Persons

If an incident involving a person who is not a certified coach, such as a parent or other support person, it should be referred to the Organizing Authority for the event. In consultation with flag officers for the yacht club, action may be taken under the club's by-laws. Privileges extended to these people to be on club premises and use club facilities, such as boat launching and dockage could be reviewed.

2.9 Allegations Of Physical Or Sexual Abuse Of A Youth By A Coach, Parent, or Support Person

Any allegation of abuse of a youth must be taken very seriously, following the procedures legally required of adults in positions of responsibility, as defined within the laws of the country of the event. Youth are typically seen to be children aged 16 or younger, but each country defines its own age limits.

The laws within each country will define abuse. The following examples of legal definitions are provided as a guideline for the information of officials but are not universally accepted definitions. It is advisable to become familiar with definitions of abuse if you work at youth regattas. Refer also to the Section in each discipline manual referring to Junior Sailors, *e.g. Section D Judge's and Junior Sailors* in the Judge's Manual.

Abuse is any form of physical harm, sexual mistreatment, emotional harm, or neglect, which can result in injury or psychological damage. The four categories of Child Abuse have been described as:

- Physical Abuse occurs when the person(s) responsible for the child's care, inflicts or allows to be inflicted any injury upon the child. Behavioural or physical indications may be helpful in offering clues that a child may have been abused.
- Sexual Abuse refers to the use of a child or youth by an adult for sexual purpose whether consensual or not. Sexual abuse can also occur among children or youth where there is a lack of consent, or among children even with consent, where there is an age gap of more than two years.
- Emotional Abuse or psychological maltreatment occurs when the person(s) responsible for the child's care either subjects the child to or permits the child to be subjected to, chronic and persistent ridiculing or rejecting behaviour.
- Neglect is the result of serious inattention or negligence on the part of a child's care giver to the basic physical and emotional needs of the child. Child neglect may be easily confused with poverty or ignorance, or may be associated with parents who are overwhelmed with other problems. However, because chronic neglect results in physical and emotional harm to a child, it cannot be ignored, whatever its case.

Neglect occurs when the parent(s) responsible for the child's care jeopardizes that care or well-being through deprivation of necessities.

Allegations of physical or sexual abuse of a youth competitor by a coach, parent, or support person must be handled expediently and carefully. All countries will have their own legal requirements on adults in positions of authority who receive such a report. Typically, the obligation is to notify the police and child protection services immediately. If you are at an event outside of your own jurisdiction, you may rely on local persons to help you to make the report. However; this will not relieve you of the obligation to make the required reports.

Reporting obligations for Adults who receive these reports include:

- If you have reasonable grounds to suspect that a child is or has been or is at risk of being abused or neglected, you must report your suspicions to the local child protection services.
- You should not conduct an investigation regarding the suspicion or disclosure. Any questions to the child should only clarify the nature of his or her complaint.
- Do not promise the youth that you will keep the information a secret.

Reporting requirements are clear for children aged 16 and under; all incidents of suspected physical or sexual abuse must be reported to the local child protection agency and the police.



ISAF RACE OFFICIALS MANUALS

Common Section 3

Crisis Management

Contents	Page
3.1 Objectives	3 /2
3.2 Introduction	3 /2
3.3 Risk Assessment and Crisis Management Plan	3 /2
3.3.1 Risk Assessment	3 /2
3.3.2 Crisis Management Plan	3 /2
3.4 Influence of Event Types on Safety Provision	3 /3
3.5 Responsibilities	3 /3
3.5.1 Competitors	3 /3
3.5.2 Race Officer	3 /3
3.6 Outline Structure of Safety Plan	3 /4
3.6.1 Dinghy and Board Events	3 /4
3.6.2 Ocean, Offshore and Yacht Racing Events	3 /8

3.1 Objectives

The Objective of any safety policy to be adopted at an event is to provide efficient, competent safety cover thereby allowing competitors, officials and all those involved maximum enjoyment whilst minimizing the risks to their wellbeing, having regard for both expected and unforeseen conditions.

3.2 Introduction

RRS Rule 1, RRS Rule 4 and standard safety Sailing Instructions confirm that a boat accepts that it is entirely responsible for its own safety. Nevertheless, safety is an area that should be actively managed, according to 'good practice', by race officers at any event at which they are involved.

The management of safety at any one event will be governed by differing procedures dependent on many factors. These factors include the types of boats involved, the numbers of boats and competitors, the course configuration sailed, the location of the race area, the sea hazards and the conditions that competitors may experience. However, events of all types have a common initial approach to safety management - a Risk Assessment and a Crisis Management Plan. It is common practice to have the risk assessment and the crisis management plan within the same document prefixed by general information on the event and the senior officials involved.

This section outlines the various issues that concern the management of the safety resources at any specific event in order to reduce the inherent risks associated with sailboat racing to a level as low as reasonably practical (ALARP). Suggestions are made which cover most forms of racing. However, whilst these suggestions are based on models that are current practice at some events, they should be regarded as suggestions and not as guidelines that must be followed as the only means of achieving best practice. Other systems exist that are equally satisfactory. Race officers will need to address the issues applicable to their own event and adopt policies appropriate to their specific requirements.

3.3 Risk Assessment and Crisis Management Plan

3.3.1 Risk Assessment

A risk assessment must be carried out for every event so that potential risks can be identified and measures taken to minimize the risk to an acceptable level.

Each risk factor is identified and described together with its possible location. The probable consequences of the risk materialising are highlighted as are the control measures that are to be put in place in order to minimize that risk. An attempt to quantify or measure the risk, having implemented the control measures, is then made. It is likely that specific control measures will be appropriate to more than one risk factor.

The process of producing a Risk Assessment may reveal deficiencies in the anticipated safety management policy initially adopted and allows the race officer to implement further control measures to minimize the risk further.

3.3.2 Crisis Management Plan

Again, this is a document that must be produced well before the event is to take place. It defines the actions to be taken when a serious risk (as should have been identified in the

Risk Assessment) is realised. The person(s) responsible for carrying out or supervising the appropriate action is identified by name or position and relevant contact details are listed. Potential sources of outside help are also defined with contact details (e.g. rescue or emergency services, hospitals, etc). Dissemination of information after such an incident must also be managed so those responsible for this aspect should be identified.

3.4 Influence of Event Types on Safety Provision

The safety management adopted differs according to the nature of the event. Factors influencing the type and amount of safety cover provided include:

- Boat types - the requirements of keelboats, dinghies, boards and model boats are very different from those of each other. Mixed fleets often pose complex problems of safety.
- Number of boats - both the type and the amount of safety cover is often determined by the number of boats and/or competitors.
- Location of racing - the safety requirements of ocean racing differ from offshore racing, racing inland or in an estuary.
- Ability of the competitors - it is often the ability of the less able sailors in the fleet that determines the level and type of safety cover necessary.
- Age of competitors - both the young and old have greater requirements when compared to fit adults.

3.5 Responsibilities

3.5.1 Competitors

RRS 1 clearly defines the responsibility of the competitor to wear a personal floatation device, whilst that rule, in addition to RRS 4, makes it clear that it is the boat's responsibility to make the decision whether or not to race (or continue to race having started) and to carry adequate life-saving equipment for those on board. It is also mandatory for competitors to assist any person or vessel, whether racing or not, that is seen to be in danger.

Sailing Instructions will require competitors to conform to a safety system that ensures that the race committee receives confirmation that a boat either intends to race and will be on the race course or that they are safe and no longer racing.

3.5.2 Race Officer

The decision to make the wearing of personal floatation devices whilst racing compulsory is that of the race officer as defined in RRS 40, unless local regulations require a PFD to be worn at all times whilst afloat. There is therefore an implied duty of care in race management. In addition, the ISAF Code of Behaviour requires all race management personnel to be responsible for their actions concerning the safety and welfare of race participants. So whilst there may be an extensive team involved in 'safety' at an event, the responsibility for this is ultimately that of the race officer in charge even when first line management is delegated to another individual(s).

The race officer must, at all times, monitor the fleet and observe the conditions in which they are racing. Priority is always the safety of the sailors whilst their boats are of secondary importance. The timing of any intervention is also important: a capsized is a normal part of some types of racing and an extreme situation in others; if the race can

continue in safety without intervention then it should be allowed to do so. Rescue facilities must remain in force until all boats, racing or retired, are safely back ashore or in a safe haven such as a harbour or marina.

Medical facilities must be available either through the event itself with a doctor onsite, or through the emergency services and local hospitals. All boats involved in the management of an event should be equipped with a first aid kit as a minimum requirement.

3.6 Outline Structure of the Safety Plan

3.6.1 Dinghy and Board Events

Having completed the risk assessment the design of an appropriate safety plan is made. This is influenced by several factors.

3.6.1.1 The size and location of the race area

Racing in coastal waters and estuaries is often monitored by VHF on the main committee boat itself. Inland races can be monitored perhaps from the club office with visual contact through a window. A means of communication with the safety fleet will still be required.

3.6.1.2 Number of race areas

The requirement for a centralized system of communication and coordination of cover is determined by the number of race areas. At a major event with multiple course areas the most efficient management of the safety systems will be effected through a centralised base. Again, this could be afloat, as in the case of an event safety leader on a boat, or ashore in an office. Communication from the safety fleets to the central base is usually via VHF radio but may also be made with mobile telephones.

When racing is on a single course it is often not necessary to have a base other than the race officer in charge or a person delegated to manage the safety resources.

3.6.1.3 Mode of assistance

Dinghies and boats that are likely to capsize are best assisted by RIBs or similar small boats. It is commonplace to have a fleet that is positioned at predetermined points on the race course. A floating base such as a mothership is a useful facility to which boats that cannot cope with the conditions are tied and made safe whilst others are rescued. A patrol plan for the RIBs is essential to effect good safety monitoring and cover. This plan must be defined and understood by all safety crews to patrol effectively when boats sail out to the race area, race and return to the dinghy park. Each safety boat will have designated area to patrol during the race and during transit of boats to and from the racing area. During the races safety boats will move to a pre-

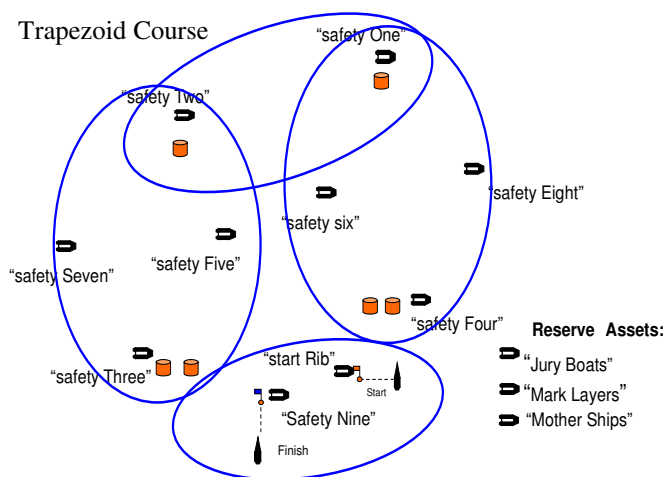

allotted patrol zone (see diagrams). Generally 1 or 2 boats would cover each leg of the course with overlapping areas around the marks. Boats should also be stationed at gybe marks as these are often problem areas. In the event of bad visibility, heavy sea, strong wind etc., boats should also be stationed at the leeward aspect of the course to 'mop up' - this is especially important if the wind is offshore. If more safety boats are available some can have a roving role.

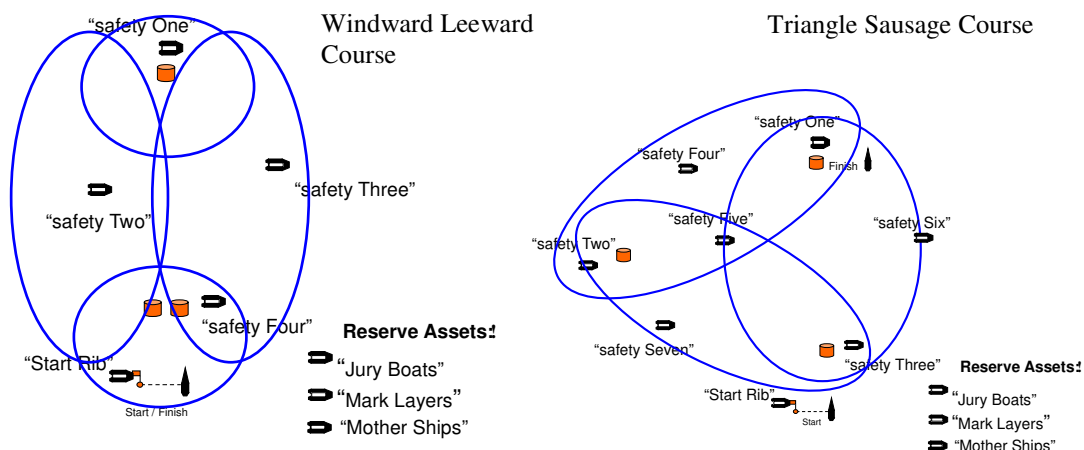

3.6.1.4 Intention to Race and Declarations

This is a requirement of the sailing instructions that enables the race officer to know who is on the water and who is on land or in harbour. In the case of dinghies and boards a tally or 'sign in / sign out' system allows the race committee to know who is on the water and who is on land.

3.6.1.5 Personnel

One individual will be assigned to the role of Safety Leader to coordinate all activity under the guidance of the race officer. There should be enough personnel in the team to provide a safety fleet appropriate to the course area, number of boats, age and ability of crews and the expected conditions. All Safety Boats should normally have a minimum of two competent adults aboard, one of whom should be dressed to enter the water to aid a rescue. There is to be no maximum number of crew but Safety Boats should not be overloaded with crew and should be able to accommodate additional sailors. It is unusual for a Safety Boat to have more than three crew members.

Other available personnel at the event should be available to help with safety issues when directed by the race officer - Jury / Umpire / Measurer / Coaches. This is not only limited to adverse conditions. Towing boats back to harbor could also be required.

3.6.1.6 Equipment

VHF radios and mobile telephones are necessary for dinghy racing.

Safety boats for dinghy events also carry:

- Adequate fuel.
- A sound generator (whistle or fog horn).
- Compass
- Anchor and warp suitable for the race area.
- Sharp knife, preferably serrated and easily accessible.

- Kill cord and spare, which must be used by the driver at all times when underway.
- Personal buoyancy for the crew, to be worn at all times.
- Safety Tape to identify abandoned boats (to be issued by the ESO).
- Paddles and bailer.
- Drinking Water.
- Tow rope (preferably made of floating line) and towing bridle.
- Waterproof first aid kit and survival bag or thermal protective aid.
- Distress Flares:- 2 orange smoke and 2 pinpoint red or 2 day/night flares.

In addition it may be desirable to carry:

- Wire Cutters, to cut away rigging and trapeze wires
- Tool kit
- GPS location equipment
- Torch
- Spare radios

3.6.1.7 Communication

Good communication is essential between all involved in any safety plan and, of course, the competitors themselves. Good briefings should be made by the race officer to the competitors before racing takes place and to the safety personnel, usually on a daily basis.

Where VHF radios are to be used it is important that all users are able to communicate effectively when the conditions are poor, which is when the activity of the safety team may be at its greatest. Wind noise is the curse of good communication by VHF so it is important that users are familiar with good technique. Call signs should be listed, VHF channels assigned and adhered to, with reserve channels should a carrier exist or when other users outside of the event also need significant 'airtime'. A procedure for radio checks is necessary.

3.6.1.8 Emergency Guidelines

In the event of an emergency occurring (including severe injury to a sailor or event personnel or structural damage endangering the safety of a boat in the event), the first boat on the scene at a dinghy event, should inform all stations using a predetermined code (such as 'Code Red') and the location of the incident. The code itself is to be defined in the safety plan and emphasized at the briefings. An immediate assessment of the situation by the race officer is made and if appropriate the incident plan then becomes active.

If the situation is considered to be hazardous to the rest of the fleet the race officer may elect to stop racing by either shortening course or executing an abandonment as appropriate.

An emergency is only declared closed when the situation has been resolved. The race officer will only then inform all stations that 'CODE RED' is cleared.

3.6.1.9 Other Issues

The following issues need to be considered as core to safety management:

- a system with which to identify boats with crews removed such as marking with streamers.
- contingency plans for a change in conditions including the onset of fog.
- a liaison with shore-side facilities and emergency services to cope with medical emergencies and injuries including a designated point for landing such incidents.
- a policy for identifying and assisting crew at a capsize and when to intervene.
- knowledge of the boats racing and how to right a capsized boat of this type (often best obtained from coaches of the class concerned).

3.6.1.10 Safety Briefings

It is important that the safety team is briefed before the event commences and also on a daily basis. The latter is to ensure that the safety personnel work as a team and refine techniques as the event progresses. Whilst the RO is responsible for safety it is common practice for the safety officer to lead these briefings, but always with the RO present. At the initial briefing the following issues need to be addressed:

- introductions of the RO and other key people.
- any local hazards.
- the ability of the competitors racing.
- the tally system in place.
- the system used to identify boats that have had their crews removed such as marking the dinghy or board with streamers.
- the location of the mothership if one is available.
- the contingency plans for a change in conditions including the onset of fog and the use of GPS.
- the methods for dealing with injuries and medical emergencies.
- the location for landing injuries and medical emergencies.
- the method to be used to patrol effectively whilst sailing out to the race area, during the race and whilst returning to shore.
- the policy for dealing with capsizes and when to intervene.
- the correct method of righting a capsized boat of the type this safety team is responsible for (and those on other course areas if appropriate).
- the VHF channel to be used and backup channels should the main one become blocked.
- the correct method for using a VHF particularly when conditions are poor with strong winds.
- the definition of when and what to transmit on the VHF particularly if there is only one channel for the course area concerned - no chatter particularly during the start sequence.
- the policy for standing down at the end of the day.
- the times of daily briefings and debriefings.
- the collection and distribution of refreshments to take out on the water.

3.6.2 Ocean, Offshore and Yacht Racing Events

The basic concepts of safety remain the same as with dinghies and boards but there are other issues to take into account.

3.6.2.1 The size and location of the race area

Course areas are extended and may be out of sight if land. Offshore racing requires a 'base' that is responsible for monitoring the location and progress of those boats involved using all technology available - tracking devices and satellite communication systems when boats are likely to be far apart; VHF monitoring both by the competitors themselves and/or a 'base' when racing is likely to be relatively compact. The base will be either afloat, as in the case of a mothership, or on land. Whatever system is used it must have the ability to communicate with both the competitors and land based rescue services. Clearly this type of monitoring must exist at all times whilst racing is taking place so is likely to be a 24 hour watch from the start and until all boats have reached a harbour or other safe haven.

3.6.2.2 Mode of assistance

The delivery of assistance to competitors is determined by the types of boats racing. Large yachts are self sufficient to a certain extent until they require the services of specialist rescue services such as is offered by coastguard agencies. In the case of injury to competitors on such yachts, they are often safer and more comfortable remaining on the yacht than being transferred to another vessel or RIB. Urgent attention is best effected by helicopter transfer.

3.6.2.3 Intention to Race and Declarations

This is a requirement of the sailing instructions that enables the race officer to know who is on the water and who is on land or in harbour. Again, it is dependent on the type of boat involved.

Yachts - common policy is a requirement that boats sail close to the main committee boat in the pre-start period and call the race committee by VHF when retiring from a race or returning to harbour prematurely. Prompt submission of paper declarations after racing is a common alternative.

3.6.2.4 Personnel

Fewer personnel are involved in safety for yacht and ocean racing. The skills of those involved are different, the main ability being communication and organisation - to alert the rescue services as is appropriate and coordinate activity where necessary whilst maintaining contact with the competitor and keeping them informed as to progress being made.

3.6.2.5 Equipment

The equipment required for ocean racing is limited to tracking devices, satellite communication systems and VHF radios. VHF radios and mobile telephones are necessary for inshore yacht racing.

3.6.2.6 Communication

Good communication is essential between all involved in any safety plan and, of course, the competitors themselves. Good briefings should be made by the race officer to the competitors before racing takes place. This is sometimes in the form of 'competitors'

notes' when boats are not located in the same place and arrive at the race area from many different locations.

3.6.2.7 Emergency Guidelines

In the event of an emergency occurring, the competing yacht should inform all stations using a predetermined code (such as 'Code Red') with incident details including its location.



ISAF RACE OFFICIALS MANUALS

Common Section 4

Race Officials and Junior Sailors

Contents	Page
4.1 Introduction	4 /2
4.2 Definition of Junior Sailors	4 /2
4.3 Race Officials Role at Junior Regattas	4 /3
4.4 Visibility	4 /3
4.5 Communication With Sailors an4 Their Coaches	4 /4
4.6 Protests	4 /4
4.7 Observers	4 /4
4.8 Use of the Protest Flag	4 /5
4.9 Reporting to the Race Committee At The Finish	4 /5
4.10 Arbitration	4 /5
4.11 Rule 42 and Appendix P	4 /5
4.12 Regatta Briefings	4 /6
4.13 Parents, Coaches and Club Support	4 /7
4.14 Support Boats	4 /7
4.15 Rule 69 Gross Misconduct	4 /7
4.16 Sailor’s Ethics	4 /8
4.17 Legal Obligations of Child Protection	4 /8
4.18 Outside Assistance	4 /9
4.19 ISAF Introductory Rules of Racing	4 /9
4.20 Sailing Instructions	4 /9

4.1 Introduction

Junior sailors comprise a major group of participants in our sport.

This section helps all race officials, but mainly judges, understand their role in the development of a child/young person centred philosophy that ensures that all junior sailors receive the greatest possible value from their participation in the sport and are encouraged to remain sailing over a long period of time. It touches on issues arising in events ranging from local club racing to international events which pose unique cross-cultural challenges and opportunities.

It is important to realise that young sailors have varying needs and interests. As a race official, you will appreciate and respect that junior sailors will be at very different levels of competence, experience and knowledge of the rules.

Adults at an event (including race officials) are in a position of leadership and trust and therefore have a responsibility to present the sport to the sailors in a way that maximises their participation, enjoyment, security and satisfaction. Coaches are usually present, and have multiple roles of support, not only of their sailors, but also in communications, race management, rescue and protest proceedings.

When children and young people are not protected from harm, injury, harassment, bullying or similar negative behaviour, their enjoyment of sailing is compromised and the likely result of this is dropping out of the sport.

At the same time, young sailors must learn how to take responsibility for their own safety and the safety of others.

There is also growing national and international concern about ethical issues in sport. Of particular concern are doping, child abuse, spectator violence, sexual assault and misconduct, lack of respect for race officials and other competitors and undue parental pressure on young children. These are all issues to be aware of if asked to officiate at a junior event.

Race Officials should be aware of the policies of all major junior classes from measurement to protests, which need to be observed in order for junior sailors to compete successfully in major events in those classes

4.2 Definition of Junior Sailors

The rules do not prescribe any age breakdown of junior sailors. However, certain class associations (e.g. IODA and ILCA) prescribe age groups for racing, and protest policies, based on the traditions and policies of their class.

For the purpose of this section, it is considered that junior sailors are generally aged from about 9 to 18 years old.

Research tells us that chronological age is a poor indicator of maturity, so an age dependent approach may not be good developmental practice. A more appropriate approach is to consider maturity in terms of readiness. Readiness assumes that certain conditions and/or experiences have been accumulated that allow the young person to learn new skills and take in new information. A child or young person's readiness will depend on his/her:

- physical readiness, e.g., mastery of fundamental movement skill, growth;

- social readiness, e.g., sense of self, support and encouragement from parents and friends;
- motivational readiness, e.g., expressing a desire to participate and/or learn and;
- cognitive readiness, e.g., ability to understand instruction, rules or tactics, in a relevant language.

In addition to understanding the unique behaviour of junior sailors, race officials need to understand that certain practices at major junior events (e.g. random measurement, display protest flag and report to the Race Committee) are driven by class association policies, and need to be observed to help junior sailors compete in major international events in those classes.

4.3 Race Officials Role at Junior Regattas

Race Officials have a significant role to play in ensuring the fairness of the competition and maintaining the confidence of the sailors, coaches and support teams.

Officials should take steps to break down the sometimes detached nature of being a regatta official, and not only administer the rules but also assist the sailors and their coaches by helping interpret the rules to contribute to the participants' enjoyment of the sport.

There is need for additional sensitivity in setting the tone of a junior regatta. It is important that sailors of all ages should be respected as individuals and not patronised.

Decisions and actions by officials can reinforce the need for good behaviour on and off the water and for taking penalties after knowingly infringing a rule.

Judges can also have a major impact on the future conduct of a sailor. Under no circumstances should sailors be allowed to feel that they will be allowed to “get away with” breaches of the rules – however minor – on account of their age. Strict and fair instruction at the start of a sailor’s career can have an important educational effect

4.4 Visibility

At junior regattas, race officials, especially judges or umpires, should focus on making themselves visible, accessible, and approachable by the sailors and their support teams. All the Race officials should be introduced at a coaches/sailors’ briefing so that sailors and their coaches can recognise them as the regatta progresses. It is also helpful for a list of judges, and if deemed helpful all other race officials (with photographs) be placed on the regatta notice board so that the identity of a particular official can be determined and contact arranged.

Particularly judges, but also other race officials, when they are ashore and not required for official duties, they should consider making themselves available to the sailors. This may involve visiting the boat park, in pairs, and being available for conversations with sailors, coaches or parents.

Circumstances permitting, it is recommended that more than one judge participates in discussions with sailors to avoid any perception of bias, conflict of interest and any other reason which may subsequently raise itself.

4.5 Communication With Sailors and Their Coaches

When speaking with sailors, use the sailor's name (ask if necessary). Also when explaining rules or interpretations with sailors, the judge or umpire should endeavour to use the vocabulary used in the rules and not change the language of the rules because the sailor is young. It is preferable, if available, to include the sailor's coach or parent in the conversation and ensure another judge or umpire is with you.

Sometimes it is more difficult for the measurer to be understood by the competitor and this is a case where the parent/coach must be present.

Particularly at junior regattas the race committee are often asked to explain when a competitor, who was scored OCS/BFD, was seen to be in front of the start line and how this was recorded. Similar to judges/umpires the race officer should endeavour to explain the circumstances in words appropriate to the rules but also add the other details he has and play either his digital recording or show the video of the start identifying the competitor.

If possible, the Organising Authority should have interpreters available at international events, as appropriate.

4.6 Protests

A significant area where the judges will interface with junior sailors is in the protest room. All sailors, but especially junior sailors, should expect a consistent and fair process, in a language they can understand.

The protest hearing should be formal, and the judges should be firm, respectful, and helpful to all participants.

Junior sailors may not have had previous experience in a formal protest hearing. The chairman should ensure that the parties, including their coaches, are informed of the processes that will be followed and if necessary clearly explain to the parties (and witnesses) the process, both initially and as the hearing proceeds. Asking at the start of the hearing if the sailors have experience in a protest hearing can be useful in deciding how to proceed.

To avoid misunderstanding, throughout the hearing and especially when communicating the facts found, conclusion and decisions, the judges should use the vocabulary of the rules. Judges should bear in mind that a younger sailor may not have a full understanding of the rules and procedures. For example, it may be appropriate to ask questions that use the definitions rather than the defined term. "Was your spinnaker ahead of the other boat's rudder?" may be a better question than "Were you overlapped?"

The need for one or more interpreter should be recognized and dealt with prior to hearings between sailors with no common language. Otherwise qualified parents, coaches and other team supporters may be used as interpreters

4.7 Observers

Observers at hearings should be encouraged at junior regattas. Besides coaches and parents being observers, it may also be beneficial for other sailors to observe the process (exclude any who will be a witness in the hearing). The chairman (or his designate) must make arrangements with the organising authority to have a room available that will accommodate the number of observers allowed. When the protest

committee secretary is scheduling the hearing, the parties should be made aware that observers are welcome.

The normal rules for observers will apply, and the observers should be made aware of these rules prior to the hearing starting

4.8 Use of the Protest Flag

Although the racing rules do not require a protest flag for boats under 6 metres (the size of most junior boats), certain Class Associations require that the protest flag be used, so sailors can learn the process (flag), and protested boats are more likely to know they may be subject to a protest and can take an alternative penalty. If a Class does not require a protest flag to be used a protest Committee cannot insist that a protest flag is used and the sailing instructions changed to bring a flag into play.

Class Associations of major junior classes including the Optimists, Sabots, Flying Ants, Flying 11, etc., sailed by sailors 15 and under have adopted policies on use of protest flags at major events. Other classes, e.g. Cadet and Laser 4.7 do not use protest flags

4.9 Reporting to the Race Committee At The Finish

It is helpful to the development of the sailors that they be the ones to decide on rule compliance on the course, and that the sailor decides whether to protest another boat or not. Certain Class Associations require that the sailing instructions contain the requirement (in addition to displaying a protest flag) that immediately after finishing the boat informs the Race Committee of their intention to protest and the boat protested. In their experience, this step is simple for a race recorder to deal with, and avoids the risk of coach prompted protests after the sailors return to shore. Other junior Class Association do not include such a requirement.

4.10 Arbitration

The use of arbitration at junior events should be encouraged. For a simple boat on boat protest, arbitration provides a process to resolve protests in a simpler manner and in less time. Interpreters must be provided as necessary to ensure due process, unless the arbitrator judge is bilingual.

Observers may be allowed, especially in cross-cultural settings, provided there is no risk that they will be witnesses in a subsequent hearing if the protest is sent back to the protest committee. Arbitration is less formal and therefore may be less pressure on the young parties.

4.11 Rule 42 and Appendix P

The use of judges on the water to monitor compliance with rule 42 should be encouraged at junior regattas. Not only does this help the sailors to understand the mechanics of rule 42 but the presence of judges on the water encourages compliance with other rules.

Apart from top level junior regattas, the Class/Organising Authority should consider changing the penalty for 3rd and subsequent penalties in accordance with Appendix L 14.4.. This assists the sailors in understanding what actions are prohibited by rule 42 and allows them to learn from their mistakes. Although the penalties of Appendix P may be relaxed at regattas by a change in the sailing instructions, the standard of Rule 42 compliance should not be relaxed and should be judged at a consistently high standard.

The judges must ensure that the Two-Turns Penalty (or retirement when required) is done correctly as described in rule 44.2. When a boat does not complete her penalty correctly she must be scored in accordance with Appendix P2.1. (i.e. DSQ).

Judges should make themselves available so that the sailors can discuss their actions that led to the penalty. On days with multiple races, the judges should, after completing their on-the-water judging duties, position their boats near the finishing so that competitors may find them.

On single race days, or after the last race of the day, the judges are best approached ashore before the protest hearings start. Judges must be able to explain the actions of the sailor and why the penalty was given. The judge should refer the rule that was broken and to any relevant ISAF rule 42 Interpretation. When the discussion is held ashore, after racing, the best practice is that one of the two judges from the boat, together with another judge from the team, discuss the penalty with the sailor. If the sailor has a coach or a parent present, that will usually make the situation easier for the sailor.

Before the racing starts the judges should be out on the course in their boats, visible to all the sailors. The judge boat(s) should be near the starting line so that all the sailors can see the judges are on the water and also identify the judge boats. This makes it easier for the sailors to find the judges if they wish to communicate with them.

4.12 Regatta Briefings

At the competitor's briefing the PRO/CHUMP/Chief Measurer/Protest Committee Chairman should decide who will introduce the following, as applicable to the event:

- Introduce and identify their discipline's officials;
- Make some positive comments about the club, the class and the regatta;
- State that the officials are there to serve the competitors, and that its prime role is to ensure fairness of the competition;
- Indicate the Protest Committee's intention to be afloat observing compliance with rule 42 and advise competitors when and how they can speak with judges or the protest committee;
- Remind sailors of the location of the official notice board and the location of the race office and protest hearing room;
- If arbitration will be used, briefly explain the process;
- Invite observers to protest hearings, as permitted in the rules;
- Advise sailors that foul or abusive language will not be tolerated;
- Request that support teams comply with any support boat instructions in the sailing instructions or other documents;
- Advise sailors that they can approach officials at any time (except when racing) on or off the water; and
- Remind sailors that sailing is a self policing sport, and their obligations under "Sportsmanship and the Rules".

For practical reasons (e.g. limited space, number of languages, class tradition.), normally only coaches will attend competitors briefings at large junior events. Clear instructions to coaches can facilitate good behaviour and rule observance by their sailors. It may be appropriate for available officials to attend the regular coaches briefing along with the

PRO and comment on rules observance and incidents, answer questions, solicit suggestions, and promote communications

4.13 Parents, Coaches and Club Support

Parents, coaches and club support are an important part of junior regattas and the development of junior sailing. Their involvement with the sailors should be acknowledged and supported within the bounds of fairness.

Younger competitors wanting to speak with an official should always be told that coaches and parents are welcome to join in the conversation, to assist the sailor in understanding the discussion

4.14 Support Boats

Support boats crewed by the sailor's support team are an important part of the safety routine at a regatta. Junior sailing would not be as strong as it is without these support structures. The movement and placement of support boats needs to be restricted, but can allow boats to move around the outside of the race area as long as they follow the limitations included in the sailing instructions and/or the coach boat regulations. For major events it is recommended that support boats be required to carry representatives of at least two different sailors or teams.

Should support boats fail to comply with the sailing instructions and the coach boat regulations, if applicable, the judges/umpires afloat maybe in a good location to remind the support boat of its obligations or note the identity of the coach boat, if they are busy policing the racing. It is best for the judges to avoid confrontation at the time and invite the boat's helm to meet with the judges/umpires at the protest room prior to the end of protest time that day, or if there is a gross breach to lodge a protest against the coach's associated competitors.

Not all young sailors will have support personnel on the water. The officials should ensure that they don't show favour or bias to any particular boats. Judge boats should not tow boats to the course area before racing, even though there is no wind. However, towing boats ashore after racing is acceptable so long as the judge shows no bias or preference to boats they give assistance, and provided that towing boats ashore is in response to a request from the race committee.

4.15 Rule 69 Gross Misconduct

It is important that all race officials recognise that in some cases it will be appropriate to conduct investigations and/or rule 69 hearings into allegations of bullying or abuse. If it is clear that there has been a one-off incident which can be dealt with under rule 69, then the protest committee should proceed in the normal manner with a hearing and impose the penalty it deems appropriate.

Any action beyond a warning must be reported under rule 69.2(d) to the national authority of the event location and competitor, if different.

A protest committee only has jurisdiction over the event in question from registration to prizegiving and any incidents immediately prior to or after it. It is not within the power of the protest committee to look into reports of misconduct that happened at other events, training camps, squad training etc.. Any such concerns should be reported to the appropriate national authority.

Any allegation of child abuse or neglect (no matter how or from whom received) must be referred to the event organising authority. It is important that the jury have some knowledge of the principles of the local laws and requirements for child protection. Some countries (AUS, USA and GBR for example) have very strict laws. Regardless of the extent of the local legislation the organizers should brief judges on the local protection laws.

Allegations of child abuse cannot be ignored. The appropriate local authorities must be notified promptly through the organising authority.

There may be occasions where the protest committee wishes to refer a matter to the local authorities but also wishes to carry on with its investigation into an alleged breach of rule 69. In these situations the protest committee must proceed with extreme caution and it is preferable that they take advice from the local authorities and the organising authority.

If it is clear that a reported rule 69 matter reported is not related to a separate allegation of child abuse/bullying, then the protest committee can proceed separately with the sporting misconduct complaint, if the local authorities are in agreement.

If the rule 69 investigation proceeds and results in a Hearing, there must be NO reference to the alleged child abuse/bullying.

If the local authorities are not in agreement, or they are not available, the protest committee should not proceed. It will always be open for the national authority to proceed under RRS 69.2 if the child protection matter is subsequently dropped.

The rationale is that it will not always be in the best interest of the young sailor, who chose not to report any suspected abuse, neglect or bullying, for a full rule 69 investigation to take place during a competition. At this time he or she is under pressure to perform, particularly where the alleged suspect is at the event.

The interviewing of children is best undertaken by trained personnel to in cases of alleged abuse, and most judges do not have such training. The worst case scenario that can result from an interview by an untrained person is that a race official, however well meaning and despite acting in good faith, could jeopardise a serious investigation.

4.16 Sailor's Ethics

It is often appropriate to remind young sailors of the behaviour standard that is expected of them in relation to the racing rules, and their relationships with other sailors. One national authority has produced a "Junior Sailors Ethical Guidelines" poster for display in sailing clubs and regatta venues. Protest committees have found the poster a convenient tool when dealing with behavioural matters at junior regattas.

The "Junior Sailors Ethical Guidelines" poster is available at:

<http://www.yachtingnz.org.nz/cmscontent.aspx?PageID=b23d1653-663d-4d5c-b09a-5eb7cec1f5fb>

4.17 Legal Obligations of Child Protection

The organizers of international events have an obligation, prior to the event, to inform members of the protest committee of all relevant local laws applicable to junior sailors at the venue. The chairman should address this with the organizers prior to the event

4.18 Outside Assistance

At a junior event with an experienced protest committee, the issue of safety on the water may make it appropriate for the sailing instructions to state that the penalty for breaking rule 41, Outside Assistance, is at the discretion of the protest committee. This can be helpful when, for example, a race committee or support boat has recovered and returned a crew member to a boat after falling overboard. Changing the penalty for such breaches of rule 41 permits the race committee or judges on the scene to promptly recover sailors without unduly interfering with the boat's race results. If protested, the officials performing the recovery will explain the incident to the protest committee, which may then impose no penalty or a penalty less than disqualification.

It is recommended that the Notice of Race and Sailing Instructions include the following:

Add to RRS 41: (e) help to recover from the water and return on board a crew member provided the return on board is at the approximate location of the recovery

4.19 ISAF Introductory Rules of Racing

In order to help newcomers to sailboat racing, ISAF have produced a one page set of Introductory Rules for Racing complete with some explanatory diagrams. The aim of the Introductory Rules for Racing is simple; make it as easy as possible for people to start racing. Consequently the Introductory Rules are as basic as possible, although they remain compatible with the principles and fundamental rules in The Racing Rules of Sailing (RRS). The Introductory Rules are being developed as part of Objective 2 of the ISAF Strategic Plan to encourage new entrants to racing and to ensure the rules are not a barrier to participation. ISAF intends that people of all ages can race using these rules without needing any knowledge of the full RRS.

The ISAF Introductory Rules of Racing are available at:
http://www.sailing.org/training/newtosailing/start_racing.php

4.20 Sailing Instructions

As much as possible, sailing instructions for junior regattas should be consistent (using Appendix L or LE) across events in matters that are not regatta specific. Regatta specific clauses include start times, description of marks, racing area, location of notice board and signals made ashore location. The sailing instructions should ideally be posted on the event website at least one week prior to the event. It is not in the interest of sailors to receive a multi-page document shortly before racing begins. Young sailors should not be expected to note the sometimes subtle changes in sailing instructions when the more important activity for the sailor at that time is to prepare for racing.

4.20.1 Changes to Sailing Instructions

For junior regattas, it may be appropriate to include the following specific sailing instruction clauses:

- Changes to Sailing Instructions (modifying L3)
- Changes to the schedule of races should be posted before the end of the protest time limit on the day before the change in schedule.
- The Start
- Boats whose warning signal has not been made shall avoid the starting area during the starting sequence for other races.

- Penalty System (modifying L14, Appendix L)
- Use the modified version in L14.4 which is recommended for junior events.
- Protests and Requests for Redress (modifying Appendix L16)
- If required by policies of the Class Association or the organizers, require all boats - regardless of length to fly a protest flag when protesting.

If required by policies of the Class Association or the organizers, require that a boat intending to protest shall, immediately after finishing, in addition to the requirements of rule 61.1(a), inform the Race Committee boat at the finishing line of her intention to protest and give the identity of the boat(s) being protested. The Race Committee should note such reports on its results log.

Unless this is detailed as a requirement in the class rules, either directly in the Sailing Instructions or by inclusion on Event Rules from the class that the Notice of Race/ Sailing Instructions includes as rules for the event – it does not apply and if the requirement is written in the class rules it is not valid.

4.20.2 Support Boats (modifying Appendix L 23)

Except when participating in rescue operations, team leaders, coaches, parents and other support personnel shall stay outside areas where boats are racing from the time of the preparatory signal for the first fleet to start until all boats have finished or retired or the Race Committee signals a postponement or an abandonment of all fleets. The areas the boats are racing is defined as the area inside the course and within xx metres (to be fixed by the Race Committee pre-regatta) of any mark, lay line, starting line, finishing line or any area where any boat that is racing is sailing or may sail.

The Organizers should circulate a *safety* plan to support boats in case an emergency arises. The coaches or team leader meeting is a good opportunity to discuss the safety plan.



ISAF RACE OFFICIALS MANUALS

Common Section 5

Handling Misconduct

Contents	Page
5.1 Introduction	5 /2
5.2 When should rule 69 be used	5 /2
5.3 Who is subject to rule 69.1	5 /2
5.4 Types of behaviour justifying a rule 69 hearing	5 /3
5.5 Who may make a report	5 /3
5.6 Form of Report	5 /3
5.7 Who should the report be lodged to	5 /3
5.8 Reports lodged with organizing authorities/clubs/other authorities	5 /4
Appendix A – Examples of Gross Misconduct	5 /5

5.1 Introduction

All race officials, competitors and other personnel are entitled to be treated with fairness and respect and it is important that these principals are upheld. The purpose of Rule 69 is to have a rule which deals with a competitor who may have committed a gross breach of a rule, good manners or sportsmanship, or may have brought the sport into disrepute.

5.2 When should rule 69 be used

The sport should not tolerate bad behaviour, and action under rule 69 is a potent way of dealing with this problem. Turning a blind eye to misconduct only serves to damage the enjoyment of those who behave properly, which in turn puts people off participating in the sport.

It is the responsibility of all race officials to deal with misconduct in an appropriate and timely manner.

If in doubt, it is better to call a hearing under rule 69, and find an allegation unsubstantiated, than not to call a hearing at all.

5.3 Who is subject to rule 69.1

A 'competitor', which means the person in charge of a boat under rule 46 and any crew member.

Rule 69.1 does not apply to other people (such as coaches or parents and other persons associated with a regatta), even if associated with a competitor, but their behaviour can be reported directly to the club, class association or MNA. A MNA can hold an investigation under rule 69.2(a).

5.3.1 The jurisdiction of the protest committee under rule 69 extends from the time competitors arrive at the venue until they depart.

If the competitor can readily be associated with the event, or if there is brawl in a public place between competitors, or if several competitors join together in bad behaviour, then the protest committee can take action. The important question is whether the behaviour of the competitors can reasonably be said to be associated to the event or to the sport.

When a club or event receives a complaint from someone who is not associated with the event about the behaviour of one or more competitors, this indicates that a connection has already been made and the sport in general (and the event in particular) may have been brought into disrepute.

Misconduct occurring after the end of the event, possibly even away from the event location, could be considered under rule 69 if satisfactory association to the event is established.

5.4 Types of behaviour justifying a rule 69 hearing

All behaviour must be considered in context – some types of behaviour should be treated as 'zero-tolerance' issues, others (such as bad language) require consideration of the context and nature of the event.

It is for the appointed protest committee to consider this however – what one race official perceives as acceptable may be regarded by others as clear misconduct. The same applies to competitors and a competitor from one culture may consider the actions or language of a competitor from another culture, on the race area or elsewhere extremely offensive.

Examples (which are by no means exhaustive) are included in Appendix A on page 5 of this section.

All competitors must be treated equally.

Any decision on a competitor's future racing is for the MNA and ISAF, if the MNA takes further action, to make.

5.5 Who may make a report

A report can be lodged by any person (who need not be a competitor). This can include:

- the race committee, or one of its members;
- the protest committee, or one of its members;
- spectators;
- passing cruising boats;
- local residents;
- the host club (if not already the organizing authority); or
- organisers or competitors of another event.

5.6 Form of report

There is no definition of the form a report must take. It may be a written or oral complaint. However, it is preferable that the report is put into writing.

5.7 Who should the report be lodged to

If a protest committee has already been appointed, then the report should be lodged with it.

However, the protest committee should involve the organizing authority at the earliest opportunity, as the hearing might better be conducted by a different or strengthened protest committee. It is for the organizing authority to appoint the protest committee who will conduct any rule 69 hearing, unless an international jury has already been appointed for the regatta.

If an international jury has been appointed, then the report should be lodged with this body and it would be the suitable body to conduct a hearing.

If no protest committee has been appointed, the report should be lodged with the organizing authority, which should then appoint a protest committee. Once appointed, the protest committee should be given the report to consider.

5.8 Reports lodged with organizing authorities/clubs/other authorities

If a report is lodged with the organizing authority, club or race committee, there is no obligation on it to refer it to a protest committee. However it is firmly recommended that they do so.

It may be appropriate for a report also to be lodged with the host club or another authority (such as a class association) for action under their own disciplinary processes.

Action under rule 69 does not preclude action by a club or other body and vice versa. However the powers of a club (which will likely include the suspension or removal of membership) are unlikely to be powers available to the protest committee.

At an event organised by a club or a class, it may be prudent and helpful for the protest committee chairman to inform a senior officer (for example a Flag Officer or responsible member of the class committee) of a potential rule 69 hearing. A constructive dialogue between race officials and the club/class is important to maintain at all events: the club/class may be able to give important background information and inform the committee of the class' disciplinary ethos.

It may be that the protest committee considers that the misconduct is best left to the club or class to deal with under their own disciplinary procedures. The committee must be confident that the club or class will take real steps to address the misconduct, as once the event ends, it will be unable to go back and investigate if matter has not been dealt with.

It must be borne in mind that it is inappropriate to discuss the specifics of a case with anyone outside the protest committee. The committee should also be wary of being told too much about the background of the competitor as this may lead it (inadvertently) to consider irrelevant information during a hearing.

A competitor can be subject to a rule 69 hearing for matters after the event, i.e. a competitor that unfairly criticises the race officials etc. on public forums after the event that brings the sport into disrepute. When the protest committee has already left the regatta site and a report alleging a breach of rule 69.1(a) is received the race committee or organizing authority may appoint a new protest committee to proceed under this rule. When similar issues apply before the event the protest committee should deal with the allegation on site.

For rule 69 procedures please refer to the Judges Manual.

APPENDIX A:

EXAMPLES OF GROSS MISCONDUCT

- 1) Engaging in any unlawful activity (e.g. theft, assault, criminal damage)
- 2) Engaging in any activity which brings the sport into disrepute
- 3) Bullying, discriminatory behaviour and intimidation
- 4) Physical or threatened violence
- 5) Deliberate damage or abuse of property (including a boat)
- 6) Deliberately disobeying the reasonable instructions of event officials
- 7) Repeated breaches of rule 2
- 8) Inciting others to break rule 2
- 9) Deliberately breaking a racing rule with the intention of gaining an advantage
- 10) Deliberate interference with another competitor's equipment
- 11) Repeating a measurement offence (intentionally or recklessly)
- 12) Lying to a hearing
- 13) Other forms of cheating such as falsifying personal, class or measurement documents, entering a boat known not to measure, missing out a mark to gain places etc.
- 14) Foul or abusive language intended to offend*

Bad language (including that not directed towards an official) has to be judged in this context. If you are uncomfortable with the language being used, then action should be taken. It is quite proper for clubs and organisers to make clear before an event that the use of inappropriate language will lead to rule 69 action. If the organisers have made this statement, then the protest committee should be prepared to enforce the standards expected. Clubs and event must set and improve their own standards.

Foul and abusive language towards race officials should be considered as dissent and forwarded to the protest committee for possible rule 69 action.



ISAF RACE OFFICIALS MANUALS

COMMON SECTION 6

Guidelines for Dealing with the Media

Contents	Page
6.1 Introduction	6 /2
6.2 Definition	6 /2
6.3 ISAF's approach to the media	6 /2
6.4 What to do and what not to do when talking to the media	6 /2
6.4.1 Do	6 /3
6.4.2 Do not	6 /4
6.4.3 Understanding how journalists work	6 /4
6.4.4 Keeping a record of press contacts	6 /5

6.1 Introduction

In this day and age where television, newspaper and internet media aim to gather news and show/publish this virtually immediately, more pressure is being laid at the feet of race officials to provide statements on what has happened during the racing or what appears *on the surface, to be controversial* decisions by the race management, umpires or jury.

Very few race officials have been exposed to dealing with the media and based on this it was decided to include in the Common Sections of the Race Official's manuals a small section which gives guidance to race officials and the notes they need to take.

6.2 Definition

Reference to media in this section refers to all types of personnel ranging from journalists writing stories for printed press and internet press to reporters producing material to broadcast on television, radio and digital media

6.3 ISAF's Approach to the Media

The approach ISAF have to the media is that the key objectives of ISAF's media programme are to:

- Promote and develop interest and participation in all types of sailing.
- Reinforce sailing as an attractive lifetime sport with a positive image that has a global reach and is universally accessible, fun and diverse.
- Promote the role ISAF plays in managing, running and developing the sport of sailing.
- To achieve this we provide relevant, interesting and varied content through our own media communications channels and work directly with sailing and other media.
- Build long-term relationships with journalists and increasing ISAF and sailings visibility through positive media coverage is important in helping to achieve these objectives.

With this approach in mind race officials should aim to follow the guidelines laid out in the following paragraphs and ensure that race officials must be mindful when they talk to the media, if it goes badly, it affects the ISAF brand.

At the initial race officials meeting each discipline should appoint a media spokesperson who is the sole person authorised to speak at media interviews or answer questions relative to that discipline. If there is a press conference all the discipline media spokespersons should be present and identified by a name plate in front of them.

6.4 What to do and what not to do when talking to the media

Remember the vast majority of media contact will be perfectly straightforward. The following guidelines should cover most situations that the race official should experience and apply to direct approaches at events or if a journalist makes contact my phone or email and will help race officials to avoid some of the difficulties you might experience in these situations.

6.4.1 Do

Try to get as much information from the media representative(s) as you can, to help both them and yourself. This can include:

- their name,
- what broadcaster, website, newspaper or magazine they are working for,
- who their audience is,
- what information they want to know,
- when their deadline is (in the case of a journalist making contact outside of an event),
- why are they producing the story/feature,
- how much information do they need (short news story or a feature?).

Offer yourself as a source of information and comment only on your area of ISAF expertise/responsibility.

If you have time constraints, tell the media representatives at the very beginning, e.g. hearings shortly starting. Similarly, ask them if they need to leave by a certain time.

Take time to educate the media representatives on a particular subject if necessary. This may well mean they come back to you in the future.

If you can, put together two or three newsworthy views/items on your subject

Prepare for any negative issues that could come to light.

Wherever possible choose somewhere to talk to the media representatives that is quiet with no interruptions and where you feel relaxed and comfortable.

Be concise. If a media representative is writing down what you are saying, they are more likely to get it wrong if you talk quickly or at length. If you are being interviewed for the broadcast media (television, radio, internet) short 'yes'/'no' answers are not very interesting and if you talk for too long people lose interest.

Be positive, passionate about sailing. Your positive attitude will reflect in what is broadcast or what a journalist writes.

Use language that you would like to hear or see in print and attributed to you.

Be natural and be yourself.

Always be calm and courteous, even if you feel angry or frustrated or if the media representative is rude.

Broadcast interviews need to be interesting/entertaining. Talk about the interview with the media representatives first to get a feel for the type of interview they want and discuss the questions with them before you start.

If you are asked a question about something you are not comfortable answering:

- In a broadcast interview simply say you cannot comment, but do not do this to all questions.
- For print and web interviews say that you cannot comment but will arrange for a suitable person to contact them. Be honest, if you do not know an answer say you will get back to the media representatives as soon as you can or will get someone to get in contact.

In a pre-recorded broadcast, web or print interview, if you are unsure if you have understood a question properly, repeat the question to the journalist in your own words to make sure that they have explained it properly.

It is all right to ask if you have answered the question adequately, but not if it is a live broadcast.

In pre-recorded broadcast interviews, it is alright to stop and ask to start again if you make a mistake.

Make a record of the contact

6.4.2 Do Not

Do not make exaggerated claims. Media representatives will always try to substantiate all claims.

Do not assume that the media representative understands the event/situation/issue as well as you do. Find out at the start what their level of knowledge is so you can give the appropriate amount of detail.

Do not say anything you do not want to see in print or broadcast. The safest rule is to regard everything you say as 'on the record', in other words will be printable or capable of being broadcast. Treat any 'off-the-record', you do not wish it to be printed or broadcast with extreme caution. Never say anything off-the-record unless you have a long-standing relationship with the media representative and have proven evidence that you can trust them. Even if you ask not to be quoted, there are no guarantees, especially if what you say is interesting or negative.

Do not go talk about aspects that you are not involved in at ISAF only talk to them about subjects you are involved in. Tell the journalist you will get the appropriate person to call back if they want to discuss a different subject.

Never make deliberately misleading statements, even to get out of a difficult situation.

Never let your guard down, even if you feel you are getting on well with the media representative.

If there is a silence, do not feel that you need to fill it. Journalists often use this as a tactic to extract more information than you want to give.

6.4.3 Understanding how journalists work

Be aware of the journalist's deadlines. If you need to get back in contact with the journalist or need to get someone else to contact them make sure you know what their deadlines are and get back in contact as quickly as possible.

Journalists generate news. Always try to present your points in an interesting way that is relevant to the context of the event/situation/issue.

Journalists like facts, figures, and interesting comments to quote in their stories, so where possible try to have some ready.

If you are being interviewed for broadcast media the journalists has to make the interview entertaining as well as interesting. They will work with you as it reflects badly on them if the interview does not go well.

Do not ask to see a draft of an article before it is printed. This infringes on the journalist's independence. A useful tactic to remember is, if the story is very technical or covers a topic that the journalist is unfamiliar with, then you can ask to see it under the pretext of offering to check the details for them.

Some journalists use tape recorders since they are more accurate than notes. This is nothing to worry about.

End the meeting by thanking the journalist and giving them telephone numbers where they can contact you and/or the ISAF media team in future.

6.4.4 Keeping a record of press contacts

Please send on the following details to newseditor@isaf.com when you have spoken to a journalist so we can keep a record of our media exposure.

- Name of the journalist
- Name of the publication
- Date of contact
- If freelance, which publication are they writing for
- Any follow up needed

If you need help contact:

Tamsin Rand – Communications Manager

tamsin.rand@isaf.com

Tel: +44 (0) 2380 635 111

Skype: tamsinrand

Daniel Smith – Website and Media Co-ordinator

newseditor@isaf.com

Tel: +44 (0) 2380 635 111

Skype: daniel.smith237



INTERNATIONAL UMPIRES' AND MATCH RACING MANUAL

SECTION A

Introduction

Contents

Page

A Introduction

- A.1 The development of umpiring
- A.2 The purpose of this Manual
- A.3 Contents of this Manual

A 2
A 2
A 3

A.1 The Development of Umpiring

'People have long complained about the time match race protests take, and about the fact that on-the-water results can be turned upside down hours later in the protest room.'
(Malcolm McKeag, New Zealand Yachting, October 1988.)

It was comments such as this that led to the development of umpiring, at a time when on the water judging (Propulsion) and the use of on the water observers were also gaining popularity. The first attempt seems a long time ago now, but it was as recently as 1987 that the New York Time wrote: 'The first tremors of an upheaval in yachting shook the sport almost imperceptibly in June when officials tested a new system that would settle a racing dispute on the water instead of the usual way, in a protest room hours after the race is finished.' (New York Times, July 27, 1987)

In a short period, umpiring has become well developed and widely accepted from club racing to America's Cup racing.

The term 'umpire' was borrowed from cricket and rowing. As in cricket, an umpire in sailing rules when asked to do so by the players. As in rowing, an umpire follows the boats around the course at a discrete distance monitoring the action. Unlike a referee, an umpire does not control the game being played.

Umpiring has many advantages for match racing such as.

- Knowing the winner with certainty at the finishing line.
- No long, contentious evenings spent in the protest room.
- Allowing a penalty to be tailored to the event and type of boat sailed, and a penalty other than disqualification.
- Keeping the game between the two boats interesting for the spectators.
- Making the game more user-friendly for players, officials, sponsors and spectators.
- Improving the atmosphere at a regatta between competitors, and between competitors and officials.
- Language, or lack of it, is no disadvantage for the competitors, because they do not have to explain and describe the incidents.

A.2 The Purpose of this Manual

The goal of this manual is threefold: The development and training of umpires, to bring consistency to the conduct of match racing, and to promote match racing world-wide. Whilst this manual is designed for match racing, we expect that these umpiring principles and procedures could be adopted for team racing as well.

The target audience for this manual is umpires and race managers, but others too might benefit from being familiar with the principles and procedures contained in this manual, such as match racers, race committee members, coaches and journalists.

This manual strives to provide the ideal. However, it is recognized that for many match races, especially informal races at club level, not all of the procedures, equipment and personnel are necessary. The principles, however, should never be compromised.

In developing this manual, we have also strived to 'Keep it Simple'; sometimes compromising for simplicity's sake where a more complicated solution would obviously be better but too difficult to effect.

The game of Match Racing is constantly developing, with the sailors continually finding new ways of exploiting the rules.

This Manual has once again been updated to reflect current practice and the Racing Rules of Sailing 2013-2016. However, it is inevitable that experience with new rules and calls will result in further ideas and improvement. Some items may become redundant. Please send your ideas for improvement together with your comments and suggestions to the ISAF as soon as possible.

This is a 'living document', to be revised regularly as experience dictates better ways of conducting and umpiring match races. Revisions will be announced by the ISAF by notice to national authorities and International Umpires, and will be available from the ISAF office. They will also be published on the ISAF Website.

A.3 Contents of this Manual

The Manual is divided into several Parts. Each Part starts on page 1, so that it can be substituted separately. The intent is that Parts in this manual may correspond to Parts in other manuals, such as the Umpires and Team Racing Manual, the Race Management Manual and the Judges Manual.

Included are some details of the ISAF certification programme for International Umpires. With the rapid development of umpiring at the America's Cup, the Nations Cup, the World Match Racing Championships, Women's and Open Match Racing Circuit and the Match Racing Grand Prix Tour, a pool of highly qualified umpires is essential. It is the goal of this programme to provide such a pool and to encourage MNA's to develop and train umpires on a national basis, providing a source from which the ISAF can certify IU's.



INTERNATIONAL UMPIRES AND MATCH RACING MANUAL

SECTION B

The Fundamentals of Match Race Umpiring

Contents		Page
B	The Fundamentals of Umpiring	
B.1	Objective	B 2
B.2	Initiation of 'Protest'	B 2
B.3	Decisions	B 2
B.4	On the Water Penalties	B 3
B.5	Techniques	B 5
B.6	Umpire skills and qualifications	B 6
B.7	Discussion	B 6
B.8	The Call Book for Match Racing	B 6

B.1 Objective

The objective has been to produce a system where penalties can be imposed and executed while boats are still racing. This enables both competitors and officials to avoid long evenings spent in the protest room and enables the winner to be identified at the end of the match. More importantly, it changes the game to a more exciting game, in which a decision on a Part 2 protest is given immediately rather than at the end of the day. A consequence of having the umpires making the decision on the water is that competitors can 'play to the whistle'. That means that a competitor is not required to take a penalty voluntarily; he takes a penalty only when required to do so by the umpires. (C7.2(b)).

B.2 Initiation of 'Protest'

Most umpire decisions are player-initiated by a boat displaying flag Y. (C6.1(a)) For such incidents, a decision will be given only after a flag Y with the umpires indicating either a penalty (the coloured flag identifying the boat) or no penalty (green and white flag). (C5)

In a case of misbehaviour (C8.3(c)), umpires may give a penalty without flag Y. It is for the umpires alone to take action on breaches of rule 31 (Touching a Mark) and rule 42 (Propulsion), errors in the pre-start requirements (C4) and some penalty procedural matters (C8.2). A competitor may not protest against his opponent for breaches of these rules. The umpires may also penalise a boat when they find that it has gained an advantage from breaking a rule (C8.3(a)), or that it has deliberately broken a rule (C8.3(b)). Finally, the umpires may terminate a match, when one of the boats has started correctly and they are satisfied that the other boat will not start (C8.5).

For a summary of 'Who can protest - how - for what', see the reference sheet at the end of Part D of this Manual'.

B.3 Decisions

Decisions can and should be given promptly - normally within a period of 5-10 seconds after the protest. If the decision takes much longer than this, it is probably due to the umpires being in doubt as to whether a boat broke a rule, in which case the following principles must be applied:

If the umpires are in doubt, they should first go back to the last point of certainty. This is the principle used by umpires to ensure that when they are uncertain whether the situation has changed or not, they will assume it has not. For example, if the umpires are not sure whether a boat has passed head to wind, they will assume she has not passed head to wind. If they had been certain that a boat was sailing her proper course, but were now not sure if she was still doing it, then they would assume she still was.

If doubt still remains, the view of the umpire whose boat they are discussing might be given additional weight. (General Principles for Umpire Decisions)

There are guidelines in the racing rules for deciding some scenarios. For instance rule 18.2(d) specifically states what to do when in doubt as to whether an overlap has been established or broken.

It is a principle of umpiring that when doubt cannot be resolved by applying the above principles, a green and white flag is appropriate. One of the main reasons for displaying the green and white flag when doubt cannot be resolved is to achieve consistency. Consistency

in decision making, not only between incidents, but also between matches and events, is essential.

It is better to dismiss a protest against a boat that broke a rule than to give an incorrect penalty to a boat that has not broken a rule.

When disagreement or doubt cannot be resolved by applying the above principles, and there has been contact between the boats, the appropriate action is to penalize both boats (twin penalty). (General Principles for Umpire Decisions) This 'twin penalty' should be used with some caution. The umpires must always first attempt to sort out the facts and applicable rules and penalize the boat at fault rather than take what may appear as the 'easy way out' by using a twin penalty.

Whenever the umpires have given a twin penalty because of disagreement after an incident resulting in contact, the circumstances should be analysed carefully after racing. The umpires should call the contact to the attention of the Race Committee so that it can check for damage. When umpires are forced to give a twin penalty for this reason after an incident involving contact, an error has occurred, either in rules knowledge or interpretation by an umpire, by failure in concentration, by bad positioning or for some other reason. It is important that umpires discuss and learn from such errors. See also D 16 of this Manual.

It is normally wise to delay a decision when the umpires expect the incident to be immediately followed by another. The time and energy required to decide the protest and to make the appropriate signals with flags, whistles and maybe penalty shapes/flags may be better spent watching for the development of the next incident. The sailors may also be too busy to watch for the umpires' signals.

With good knowledge of the rules, good concentration and good positioning, doubt can almost always be avoided. Absence of doubt is the mark of a good umpire.

B.4 On the Water Penalties

Rule C7 describes the penalty system. The Sailing Instructions may modify this penalty system, but the current Appendix is now well tested.

The objective of a penalty is not to remove a boat from a race but to ensure that the penalized boat is disadvantaged. This is achieved by giving a penalty, which should cause the boat that broke a rule to lose about 2 to 4 boat lengths.

Routine Penalties

The penalty system, commonly known as the delayed penalty system, is described in rule C7. It permits a penalised boat with one outstanding penalty to take that penalty anytime during the match after starting and before finishing. Should a boat get a second penalty, she must always take one of them as soon as reasonably possible (but never before starting), even if the second penalty is signalled when her spinnaker is hoisted. A boat with more than two outstanding penalties will be given a black flag, and the match will be terminated and awarded to the other boat.

The penalty varies on different legs of the course. If a boat is sailing to a windward mark, the penalty is to gybe and, as soon as reasonably possible, luff to a close-hauled course. (C7.2(a)(1)) If a boat is sailing to a leeward mark or the finishing line, the penalty is to tack and, as soon as reasonably possible, bear away to a downwind course. (C7.2(a)(2))

Note that a windward mark is one that is named Mark W in the sailing instructions, and a leeward mark is Mark L – this does not change even if there is a huge wind shift, the penalties are always the same on those legs.

If a boat has one or two outstanding penalties and the other boat in her match is penalised, one penalty for each boat is cancelled (offset) (but see below under *More Serious Penalties*). The umpires display coloured shapes or flags to inform every one of any outstanding penalties.

The benefit of this penalty system is that it keeps boats close together throughout the race. A penalised boat will try to get the other boat to break a rule, so that the penalty will be cancelled. This leads to aggressive, exciting sailing. A penalised boat will normally wait to take her penalty until she is far enough ahead that she is likely to still be in control after taking the penalty, or wait until just before finishing. The outcome of a match may be decided in the last 10 seconds of that match.

More Serious Penalties

Sometimes breaking a rule and getting penalised leaves a boat in a better position than she would have been if she had not broken a rule. In such cases the umpires have several options:

1. To give the penalty as a red-flag penalty (C5.3).
2. To give an additional, umpire initiated penalty (C5.2).
3. To display a black flag (C5.4).

A brief delay in making a decision may be justified when judging whether a boat has gained a controlling position by breaking a rule. The umpires may want to give the boat a red-flag penalty if she has. (C5, C6.5(b) and C7.3(d)).

The additional, umpire initiated penalty is meant to take away an advantage gained by a boat that broke a rule, especially if that advantage was gained through a deliberate breach of a rule at a critical time e.g. breaking a rule to avoid being OCS, barging at the start and denying an inside boat room at the mark. It may also be given to a boat that commits a breach of sportsmanship, and in such a case, the umpires may initiate the penalty without any flag Y from a competitor. (C8.3 and MR CALL M2)

Many umpires have been reluctant to give a boat two penalties. Often, two penalties given for one incident early in the match meant the end of any real competition between the boats. The boat that was penalised was several boat lengths behind and did not have a chance to catch up while sailing in the other's control and in its bad air. A match for whom there is no hope of winning is boring for all concerned. However, it is important that when the conditions for an additional umpire initiated penalty have been fulfilled, the umpires give such a penalty. The sailors do take 'calculated risks' - they barge in at the start and expect to either get away with it, or to get a red-flag penalty. In case of a red-flag penalty under such circumstances, the outcome is that the sailor will have to take a penalty and after the penalty will find himself in the same spot as before the incident - but with no outstanding penalty. With a double penalty, the boat gets back to where she would have been without the breach, but she also has to carry a penalty for the breach.

When the umpires judge that a boat has gained a controlling position as a result of breaking a rule, but they are not certain that the conditions for an additional umpire initiated penalty

have been met, they display a red flag with or soon after the penalty flag. The boat that gets the red-flag penalty must take the penalty as soon as reasonably possible (but after starting). If one boat has a penalty and the other receives a red-flag penalty, the red-flag penalty does not cancel the outstanding penalty. (C7.2(e))

The red-flag penalty is designed to restore the relative positions of the boats before the incident that resulted in the penalty. It does not relieve the other boat of an outstanding penalty the way that a double penalty (two penalties for the same incident) would.

If, after a boat has completed a red-flag penalty, she still has an advantage, and the requirements in C6.5(b) are fulfilled, the umpires may give her another penalty, and this could be another red-flag penalty. (C8.3).

B.5 Techniques

Some of the techniques used for effective umpiring include::

(a) A 'Team' Effort

Although it may be possible at a low level event to umpire a match using a single umpire, the standard and better procedure is for two umpires in one boat to follow the match and umpire together. The two umpires work as a team, sharing fully the responsibilities and work of the team, such as driving the boat, use of the radio, displaying flags, cleaning the boat at the end of the day and, of course, making the calls. It often happens that one umpire is more experienced or more dominant in personality than another umpire. That umpire must strive to include the other umpire in every aspect of the umpiring and work hard at being a 'team'. A third member of the team in a wing boat (known as the 'Wing Umpire') is also desirable.

(b) Positioning and Proximity

Positioning of the umpire boat is all-important, for without proper positioning the umpires will not get an adequate view to make accurate judgements.

(c) Observing and Deciding

Each umpire 'adopts' one boat, and play the role of that boat. A safe system is for the umpire on the port side of the umpire boat to adopt the Blue boat, and the umpire on the starboard side of the umpire boat to adopt the Yellow boat. The umpire constantly considers what his boat is doing and what it will or can do, and states this aloud. The umpires thereby talk through each situation with each other and will often have decided the incident as it occurs. This method is further described in D 11 of this Manual.

(d) Concentration and Anticipation

Concentration and anticipation are two keys to successful umpiring.

It is essential that the talking mentioned in paragraph (c) above continues throughout the match as this greatly assists the umpires to concentrate and thereby produce good judgements.

An umpire is required to develop a good understanding of match racing tactical moves and even good knowledge of the possibilities and limitations the specific boats used provide, for it is important to be able to anticipate the next most likely action. Discussion between umpires and experienced match racing skippers or

tacticians is an excellent way to help improve the understanding of the game. See also D 6 of this Manual.

(e) **Developing an 'Automatic Pilot'**

Umpires need a constant overview of the situation: wind conditions, current, local circumstances, etc., which may affect each boat's options. They can then consider the tactical moves the boats may make, and what rules apply between them. This information plus the facts of the actual situation enable the umpires to determine the best place for their boat. Being in the right position is essential for reaching good decisions on incidents.

This whole process of answering a Y-flag is too time-consuming for the umpires to go through it consciously, so it needs to become automatic. To achieve this they need to practice on the water or with models, or visualize mentally, and to try it again and again. The next step is to review it continually and improve it until the whole process becomes automatic.

Once this process has become automatic, it releases capacity for talking and decision making - and all umpires should work on improving this ability.

B.6 Umpire Skills and Qualifications

The skills and qualifications needed of an umpire are set down in the documents listed in Part N of this Manual, and umpires at all levels should aim to improve on their skills as much as possible.

Note that the skills list does not only address technical matters but also puts considerable emphasis on the temperament and behaviour of the umpires. One example would be confidence. A good umpire will have confidence but never complacency and he will be able to demonstrate his confidence in his relations with competitors, committees, press and the public.

B.7 Discussion

Umpiring decisions must not only be made in accordance with the Racing Rules of Sailing, but as far as possible must be seen to be so. This 'visibility' can be enhanced by discussions, both before and after sailing, between umpires and competitors. These discussions are a proper part of the process and should be encouraged. See D 5 and 6 of this Manual.

B.8 The Call Book for Match Racing

To ensure consistency in the interpretation of the rules among competitors and umpires, ISAF has published The Call Book for Match Racing. This is an authoritative ISAF document whose status is equivalent to that of the ISAF Case Book. This book is an all-important tool for the umpires, and they are required to follow it.

The Call Book is under constant development, and the procedures for new calls and amendments are contained in it.

A big improvement is the ISAF Rapid Response Match Racing Call Programme, where all IU's can submit proposed calls to ISAF. The Rapid Response Match Racing Group will consider such calls, normally within four weeks. When a call is accepted, it will be

communicated to all International Umpires and MNA's and also posted on the ISAF website. A Rapid Response Match Racing Call is valid from the day it is accepted, and will be considered for inclusion in the Call Book for Match Racing at the first ISAF Annual Conference where it can be submitted.



INTERNATIONAL UMPIRES' AND MATCH RACING MANUAL

SECTION C

Appendix C – Match Racing Rules

Appendix C is part of the Racing Rules of Sailing. Together with the Call Book for Match Racing and the current Rapid Response Match Racing Calls, the Sailing Instructions and Notice of Race for each event, and relevant cases from the ISAF Case Book, they form the rules for Match Racing.

All Umpires, Race Officials and Sailors need to have the current version of the Racing Rules for Sailing.



INTERNATIONAL UMPIRES' AND MATCH RACING MANUAL

SECTION D

Mechanics of Umpiring

Contents	Page
D Mechanics of Umpiring	
D 1 Preparation	D 2
D 2 The Chief Umpire	D 2
D 3 Initial Umpire Team Meeting	D 3
D 4 Umpires Meeting with Race Committee	D 3
D 5 Umpires Meeting with Competitors	D 3
D 6 Post-Race Debriefings	D 4
D 7 Driving the Umpire Boat	D 5
D 8 Radio Communication	D 6
D 9 Using a Radio	D 6
D 10 Umpire Equipment	D 7
D 11 Umpire Interaction	D 7
D 12 Umpires' Instantaneous Calls	D 12
D 13 Wing Umpires	D 13
D 14 On-Board Observers	D 13
D 15 Penalty Signals	D 14
D 16 Umpire More Consistently	D 16
D 17 Signalling	D 17
D 18 Umpire and Wing Boat Etiquette, Positioning	D 18
D 19 Visitors on Umpire Boats	D 19
D 20 Red-flag Protests	D 19
D 21 Umpiring Team Assignments	D 20
D 22 On-Shore Duties	D 21
D 23 Incident Report Forms	D 22
D 24 Explaining Decisions to Competitors	D 22
D 25 One on One communications with competitors or rules advisors	D 23
D 26 Explaining Decisions to the Public	D 23
D 27 Press Conferences and Individual Meetings with the Press	D 23
Briefing Check Lists - Umpire & Jury Team	D 25
Briefing Check Lists - Umpire/Race Committee	D 27
Umpiring Team Assignments	D 29
Match Racing Incident Report Form 1	D 30
Match Racing Incident Report Form 2	D 31
Match Racing Protests	D 32

D.1 Preparation

The days before the racing starts should be used by umpires to prepare themselves for the event. Even those who umpire regularly should:

- (a) Look through the Call Book and the Rapid Response Calls.
- (b) Re-read Appendix C.
- (c) Re-read Part 2 and the Definitions of the RRS.
- (d) Obtain and read carefully the sailing instructions.
- (e) Review the Mechanics and Scenario Parts of this Manual.

It is also helpful if an umpire takes the helm for a short while of one of the boats to be used. Spin it, consider its turning arc, test its response to sudden tiller movements, and time it through a tack. An umpire needs to know what a helmsman can and cannot do with his boat.

If there is no opportunity to sail the boats, umpires are wise to follow the boats when they are practising to obtain this kind of information. Unless the boats are obviously preparing for their pre-start, it is quite all right to go up and ask them to show you some manoeuvring.

Before each match, the umpires should always check the ID flags on their boats in good time before the attention signal. They should advise the boats on any mistakes regarding the flags before the boats start racing. Even if a boat enters with the wrong ID flag, the umpires should advise her that the display of the flag needs to be corrected immediately (rule C8.2). In this way the umpires can avoid having to penalise a boat for displaying the wrong flag or none at all.

Most umpires will find it useful to 'load the tapes' in the minutes before the start of the day's first match by for example running through the seven possible scenarios for the First Cross. (See reference sheet at the end of Part F of this Manual – F16) By running through them, and at the same time visualising their own positioning, they will get up to speed and be ready for the action.

If there are any matches preceding your own, it is also useful to 'shadow-umpire', provided you do not get in the way!

D.2 The Chief Umpire

The special duties of the Chief Umpire will include:

- (a) Act as the link between the Race Committee and the umpiring team, both ashore and on the water.
- (b) Act as representative and spokesman for the umpiring team at meetings, functions, press conferences, etc.
- (c) Decide how, where and when on-the-water protest hearings will be conducted and make all the arrangements. (Unless separate Protest Committee Chairman.)
- (d) Prepare and distribute the umpiring team assignment sheets unless delegated (see examples at the end of this Part of the Manual).
- (e) Re-arrange the team duties on the water in cases of boat breakdown or other problems.

- (f) Arrange for and chair the initial meeting of the umpiring team.
- (g) Arrange for and chair the umpire/skippers meeting.
- (h) Arrange for and chair the umpires' post-race debriefing meetings.
- (i) Collect incident report forms, if used.
- (j) Assign any further on-shore duties to the umpires (as described in D 22 of the Manual).
- (k) Complete and dispatch the ISAF Match Race Report forms.
- (l) Confirm the events Grading and Report Form.
- (m) Fulfil all the normal duties of a protest committee or jury chairman, if appropriate.

It is usual, but not mandatory, for the Chief Umpire to be also the Chairman of the Protest Committee or Jury. At a high level event or an event with several matches in each flight, an alternative solution is to separate the duties as Chief Umpire and Chairman of the Protest Committee/Jury. It is also common for the chief umpire to be consulted on various matters, such as notice of race and sailing instructions, before the event.

D.3 Initial Umpire Team Meeting

The initial team meeting should be held in adequate time before the racing begins. When boat drivers and/or observers are to be used, they should also attend the meeting.

Matters to be covered will depend upon the event. A checklist that provides a variety of matters that could be covered at this meeting is attached at the end of this Part of the Manual.

D.4 Umpires Meeting with Race Committee

The Chief Umpire should meet early with the Race Committee (this meeting could involve all umpires).

Matters to be covered will depend upon the event. A checklist that provides a variety of matters that could be covered at this meeting is attached at the end of this Part of the Manual..

D.5 Umpires Meeting with Competitors

Before racing begins (and preferably after practice racing) the umpires should meet with all skippers (plus their crews if skippers wish and there is room available). The contents of a briefing before racing will vary strongly and depend upon the level of experience among the competitors.

With experienced competitors, it may well be sufficient to ask whether they have any questions, whereas with sailors with little experience various matters may be covered, maybe even the starting procedure.

The Chief Umpire may select matters for the briefing from the following list:

- (a) Sailing instruction amendments and any unusual provisions.
- (b) Umpire boat identification.
- (c) Displaying and removing the Y-flag.

- (d) When penalties will be signalled.
- (e) Unacceptable behaviour.
- (f) Procedures for on-the-water protest hearings.
- (g) Post-race debriefings.
- (h) Drawing attention to written answers to written questions.
- (i) Briefing on the umpires' approach to any particular rules discussed at the initial umpire team meeting.
- (j) The umpires' policy on matters on which Appendix C allows umpires to take direct action.
- (k) Questions of clarification from competitors. Answers should be in writing and posted on the official notice board.

This meeting may follow the briefing of competitors and it is good policy for umpires (always the Chief Umpire) to attend that meeting as observers..

D.6 Post Race Debriefings

Debriefings provide a great learning opportunity for umpires and competitors. A short meeting of umpires and competitors at the end of each day's racing should happen at all events whether it is a Grade 5 event or a Grade 1 event. At this meeting, any of the day's problems can be discussed, and umpires who had any interesting or difficult calls can explain the circumstances.

Umpires have an obligation to explain their calls to all competitors and umpires. Sharing their facts of an incident with competitors and umpires leads to consistency and learning by all.

A group discussion, using boat models preferably on a magnetic whiteboard, will be of benefit to everybody.

Many skippers and crews appreciate the opportunity to be present at these meetings. Their attendance should be encouraged, as should discussion on calls and any differences in opinion.

Whenever two people, umpires or competitors, think that different things happened, they are unlikely to change their mind. We all see things differently, and it is important to bear this in mind. It is important to distinguish between differences of opinion relating to what happened (facts) and interpretations of the rules. When there is a difference in opinion as to what happened, it is important to leave everybody clear: both opinions should be presented thus;

if this happens - this is the call,

if the other happens - this is the call....

When a competitor and an umpire seem to disagree about the facts of an incident, it is often a good idea to ask the other competitor involved in the incident to describe how he saw it. His opinion on the facts may either contribute to make the facts clear or at least convince the first competitor that the situation was experienced differently.

Umpires should be prepared to own up any errors quickly and graciously.

Discussions about how the rules and the Call Book might be improved do not belong in a debrief. They can, however, be very valuable, and the Chief Umpire may suggest to have a chat about it (in the bar) afterwards.

When situations occur that are not included in the Call Book, it is important to decide how to call them the next time. Find out what the rule actually says. If the rule is clear, do what the rule says - even if you don't like it.

If the rule is not clear, find out what the general feeling is about which way to go, and go with the majority. When there is a divided opinion, the Chief Umpire must decide. It is important to make it absolutely clear that whatever is being decided is for that regatta only.

Any new calls should be recorded on the Umpires Match Race Report Form from the event and sent to the ISAF office - they should also be submitted to the Rapid Response Match Racing Call Group.

There have been occasions when competitors have behaved aggressively at debriefs. One way of avoiding that, when a competitor seems to be upset when he arrives at a debriefing, is to state that everybody is there to learn, not to argue. Invite each competitor to give his opinion about what happened, using the model boats. Permit the opponent to agree or disagree. In this way, the competitors might solve the problem themselves.

If competitors start to be abusive, they should be reminded why they are present. It would be advisable to have a word with the competitor afterwards and point out that abusive behaviour could lead to a hearing under rule 69.

D.7 Driving the Umpire Boat

Umpire boats should be driven by one of the umpires. Some owners, who provide their boats on loan for umpiring, understandably wish to drive their own boats, however, this makes umpiring very difficult unless the owner is an experienced match racer or an umpire.

The advantage of an umpire driving is that the boat can be placed exactly where the umpire requires without the need to give directions to another person. The disadvantages are:

- (a) Many boats have particular handling characteristics unknown to the umpire and;
- (b) If the umpires are required to follow the boats into a crowded spectator fleet during the pre-start, it may be difficult to both manoeuvre the boat and watch the boats. This means that one umpire is out of action just when full attention needs to be given to the boats.

Sailors with good rules knowledge can make ideal drivers and soon learn to place the boat where the umpires require. For important matches such as finals, there are usually unallocated umpires who can drive and position the boat accurately leaving the umpires on duty to concentrate fully on the boats.

If needed, hand signals can be quickly agreed between umpires and their driver so that the driver can continue to receive direction while the umpires are conversing. 'Ahead', 'right', 'left', 'fast ahead', 'stop' and 'turn' are usually adequate. To avoid possible confusion, all directions to the driver should come from one umpire only.

Before the first match the umpire boat should be put through its paces, so the umpires can understand its capabilities. How quickly can it turn, reverse and accelerate? Half way

through the first pre-start may be too late to discover your boat always stalls when put into reverse, or has some other peculiar characteristics.

D.8 Radio Communication

At a principal event there should be a radio system allowing communication between umpires and wing umpires, umpires and Chief Umpire, and Chief Umpire and RC. (RC should have one radio on the umpire channel in order to receive messages for instance about outstanding penalties.) The ideal system would be to have separate channels for each match, but it is more usual to have only one channel.

With one channel there are certain standard procedures:

- (a) Radio traffic is kept to the minimum, particularly when another match is in its pre-start period.
- (b) Priority on radio use goes to a match in its pre-start period.
- (c) Identification is needed by prefacing each transmission with the match number (e.g. 'Match Two zone clear').

NOTE: This preface is not used by the match that is in its pre-start period. Umpires can therefore assume a call with no preface applies to the two boats that are in the pre-start.

For general radio traffic, the 'call signs' for each boat are 'Umpire One', 'Umpire Two', etc. and 'Wing One', 'Wing Two', etc.

D.9 Using a Radio

There are standard procedures for using a radio, and these key points should be observed for general radio traffic.

- (a) Establishing Contact

Your call to establish contact with another station consists of 'CALL SIGN this is CALL SIGN' (e.g. 'Umpire Two this is Umpire Three' or 'Umpire Two, Umpire Two this is Umpire Three').

When Umpire Two receives your call he will respond the same way (e.g. 'Umpire Three this is Umpire Two').

Note that the station being called is stated first. Do not call 'This is Umpire Three calling Umpire Two'.

Do not call 'Do you receive me?' This is an example of unnecessary wording, if the called station has received you, it will respond; if it has not received you, there will be no response.

Due to the possibility of the short word 'No' being lost in a radio transmission, umpires and wing umpires substitute the word 'Negative' (e.g. 'Negative contact').

- (b) The Conversation

Once both stations are in contact, your procedures can be more informal, but remember to keep them to a minimum.

The words 'over' and 'out' should be avoided except when your receiver may be in doubt about your intentions. These words denote:

OVER This is the end of my message to you and a response is necessary. Go ahead and transmit.

OUT This is the end of my transmission to you and no answer is required.

(c) **Voice Procedures**

CLARITY Do not slur. Get your message clear in your mind before you speak.

CONCISENESS Keep every message as short as possible.

RHYTHM Divide messages into sensible phrases.

SPEED Speak more slowly than normal.

VOLUME Same as normal conversation. Shouting causes a distorted transmission.

(d) **Noise**

If possible, move away from any background noise such as the engine.

Shield the microphone. Wind blowing into the microphone will distort your transmission. A small plastic bag over the radio or microphone may help.

(e) **Confidentiality**

Radios are not the place for confidential messages. You can assume that every time you use the radio, your conversation is being monitored by outsiders. Also watch your language.

D.10 Umpire Equipment

The equipment needed by umpires is covered in Part J of this Manual.

Every umpire is expected to carry his own whistle, which needs to be of good quality. The type used by referees at football matches have a sound that carries over long distances.

D.11 Umpire Interaction



The principles of the two-umpire system have been covered in Parts B2, B3 and B5 of this Manual.

A further key to successful umpiring is good interaction between the two umpires. This is helped by the umpires standing or sitting close together, speaking loudly and clearly so that each can hear the other. This should keep both umpires' opinions in step.

If opinions get out of step, the umpires must immediately resolve the difference. If they have a difference of opinion, then perhaps the competitors have a similar difference and an incident may be imminent. The conversation between two umpires could be, for example:

Yellow: 'I am right of way - leeward - I can sail above proper course - I must give you room if I change course..'

Blue: 'NO! You established the overlap from clear astern. I am keep-clear boat, I am keeping clear.'

Yellow: 'I agree'.

Here the difference of opinion is immediately resolved. If the first umpire had not corrected himself by saying 'I agree', then further speedy discussion would have been needed to resolve the difference. Had the first umpire not been speaking loudly and clearly, then the difference of opinion might not have been detected.

An umpire's conversation should not over-emphasise what his boat is doing. It should concentrate on what his boat must do, or must not do, or is permitted to do, or is not permitted to do.

Each umpire starts with the RIGHTS - this determines who has right of way and who has to keep clear.

Next in line are the REASONS - the reasons why a boat has right of way: Starboard/Port; Leeward/Windward; Clear ahead/Clear astern; Not moving backwards/Moving backwards; Not taking a penalty/taking a penalty, etc.

The boat's OBLIGATIONS are next - the need to 'keep clear'; the need to give 'room'; not permitted to sail above close-hauled; not interfere with a boat on another leg, etc.

Finally the boat's OPPORTUNITIES - to sail above close-hauled; to hunt (change course); to tack; to go for an overlap, etc. If the umpire knows what opportunities his boat has available, it will be easier for him to anticipate the boat's next move.

An umpires' conversation using these principles correctly could be:

Blue: 'I am right-of-way boat - I am on starboard - you must keep clear - I can hunt you' (RIGHT - REASON - OBLIGATION on Yellow - OPPORTUNITY).

Yellow: 'I must keep clear, I am on port. If you change course you have to give me room to keep clear' (RIGHT - REASON - OBLIGATION on Blue).

It is equally important to keep the communication a two-way communication, for instance by asking questions like: 'Can I gybe here', 'Can I cross', 'Is there room for me to establish an overlap'..... In order to force oneself to listen to the other umpire, it is also a good idea to say 'agree' whenever it applies.

By focusing thoughts and conversation on **Rights, Reasons, Obligations and Opportunities**, many incidents will be resolved even before a boat Y-flags.

How can we Improve our Umpiring

Umpire Faster.

The first contribution is to make the communication between the two umpires even more effective. Figure 1 illustrates the process of deciding a protest as a linear movement through a sequence of boxes.

1. Facts	2. Right + opportunity	3. Obligation + fulfillment	4. Decision
Starboard	Right of way	Keeping clear	No rule broken
Port	Can luff	Giving room or mark-room	Rule broken by:
Overlap	Can bear away	Not above proper	Blue boat
Clear ahead /astern	Can sail above proper	course	Yellow boat
Windward	Can tack	Gybing as soon as possible	Gained controlling position
Leeward	Can gybe	Not interfering	Gained advantage
Tacking	Deliberate foul
Luffing			Green / Penalty flag
Bearing away			Red flag / 2 penalties
Holding course			
Head to wind			
Contact			

Figure 1: The process of deciding a protest

We start this movement by finding the relevant facts (Box 1), which we use to determine the rights and opportunities of the two boats (Box 2), and both of these elements together provide us with an understanding of their obligations and the extent to which they fulfill them (Box 3), and this in turn enables us to make a decision that we signal to the competitors by waving a flag (Box 4).

The figure can also be seen as the learning curve of an umpire. As novice umpires our first attempts to communicate with our fellow umpire primarily involves calling of *facts*; we describe the positions of the boats, their relationships, courses, etc. by means of concepts like those listed in Box 1 of Figure 1.

In order to illustrate the fact-based mode of communication, we can focus on the luffing maneuver depicted in Figure 2.

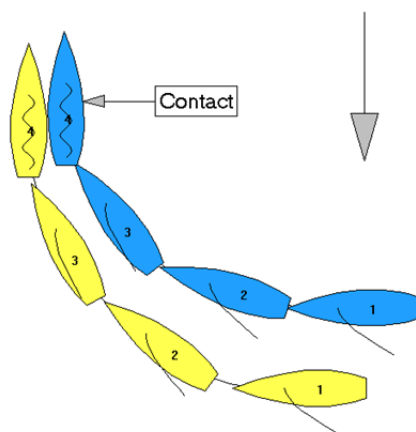

Figure 2: A luffing maneuver

The leeward boat luffs, and in order to simplify the example; we assume that Yellow is not limited by rule 17. When the two boats protest in situation 4, we must decide if Blue violated its obligation to keep clear (rule 11) or if Yellow violated its obligation to give Blue room to keep clear (rule 16.1). In order to understand how this decision is made, we can examine the calls that are made by the umpires. With the maneuver in question a communication mode based on *facts* could typically involve calls like these:

Situation	Yellow umpire	Blue umpire
1	I am on starboard tack; We are overlapped; I am leeward boat; I am holding my course	I am also on starboard tack; I am windward boat; I am holding my course
2	I am still leeward boat; I am luffing	I am starting to luff; The distance between us is four meters
3	I am continuing to luff; We are still overlapped	I am still luffing; The distance is now one and a half meter
4	I am head to wind; I am still on starboard; I am holding my course	I am also head to wind; I am holding my course; There is contact abeam; Yankee flag

This communication mode is not optimal. The umpires call several facts of minor relevance, they have troubles calling all they want in the time available, and when the boats are protesting in situation 4, it may take quite a while before they reach a decision. The problem is that they communicate in Box 1 and do not work their way through Box 2 and 3 until there is a protest. The result is that their decision-making process seems to take very long.

To make the communication more effective, we might switch to the mode where we call **rights and opportunities** for the two boats instead of facts. That corresponds to Box 2 of Figure 1. With the maneuver in Figure 2, the communication about rights and opportunities will typically involve calls like these:

Situation	Yellow umpire	Blue umpire
1	I am leeward boat; I am right of way; I can luff if I give you room to keep clear	I am windward boat; I must keep clear
2	I am luffing and I must give you room to keep clear	I must keep clear; I am starting to luff
3	I am luffing and I must give you room to keep clear	I must keep clear; I am luffing
4	I am head to wind; There is contact abeam	I am also head to wind; Yankee flag

The calling still involves issues of minor relevance. It is a clear improvement that Yellow acknowledges in Situation 2 that she must give Blue room to keep clear. Yet the problem still is that the conclusion concerning rule violation is not discussed until the contact occurs. This discussion corresponds to working through Box 3 of Figure 1. That takes time and, in addition, the umpires to some extent need to reproduce to each other the manoeuvring of the two boats throughout the incident.

To make the communication even more effective, we should aim at making decisions throughout the development of an incident. In order to accomplish that, we can communicate about the two boats' **obligations and fulfillment** of these obligations. That corresponds to Box 3 of Figure 1.

The umpire statements deal with the obligations of their boat and its fulfillment of these obligations. Thus a working umpire may continuously think and call in terms of the

decision structure provided by figure 1. If we communicate about obligations and fulfillment with the luffing maneuver in Figure 2, calls like these would be typical:

The words in **bold** are the words actually called by the umpires.

Situation	Yellow umpire	Blue umpire
1	I am right of way leeward boat	Agree ; I am keeping clear
2	I am luffing and must give you room to keep clear	I am doing what I can to keep clear
3	I am still luffing ; Do you need more room?	I am luffing all I can ; I need more room to keep clear
4	Contact ; I did not give you enough room	Agree; Yankee flag; Penalty on Yellow

At every point in time, both umpires determine if their boat fulfils its obligations instead of calling its rights and opportunities. They also express whether they agree or disagree which confirms that they are actually listening to each other. Consequently, it is very quickly in situation 4 to decide that Yellow did not fulfill its obligation and must be penalized accordingly. When this mode of communication is conducted in an optimal manner, the umpires often experience to have decided a protest well before the boats have even waved their protest flag.

The core of this decision-making process is in a simplified manner illustrated in Figure 3.

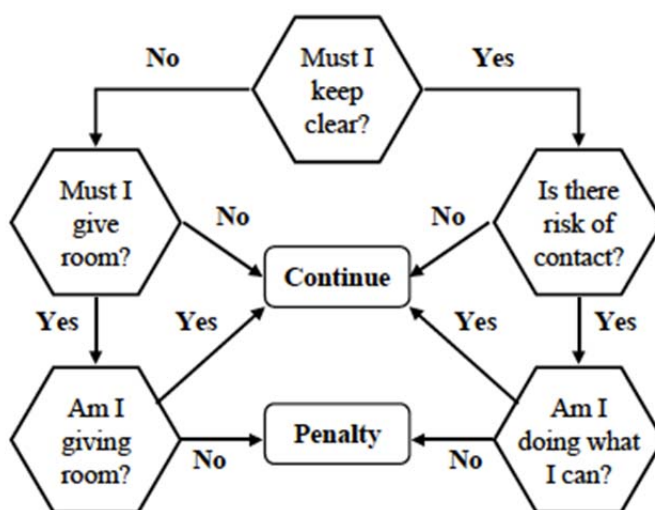

Figure 3: Umpire decision-making

This mode of umpiring requires considerable training. But once you succeed, the process of deciding a protest becomes much simpler and quicker. When the amount of information communicated between umpires is reduced considerably, they suddenly find time to try predicting what the next maneuvers of the boats will be, and that in turn facilitates a more relevant communication about obligations and fulfillment. Furthermore the reduced amount of speaking required by the umpires gives them more time to listen to each other and to listen to information from wing boat and/or onboard observers. Note that ‘room’ represents both ‘mark-room’ and ‘room’.

The only problem found so far with this mode of communication is that we may end up in a situation where we realize too late that we are missing a fact. When our communication deals only with Box 3, we may not see this before the protest is there, and then it is either

too late to reestablish the fact or it takes too much time. In order to avoid this trap, we should trace our calls back to the underlying facts whenever we have time.

D.12 Umpire's Instantaneous Calls

In addition to the 'RIGHT - REASON - OBLIGATION - OPPORTUNITY' information passed between the two umpires (Part D 11) there will be a number of moments when an umpire must make an 'instantaneous call', like a photograph that captures a particular moment in time. These calls must be concise and be made at the exact moment they apply.

The most frequent instantaneous calls will be for:

- Close-hauled (after tacking)
- Starboard/Port (after gybing)
- Head to wind
- Tacking (passed head to wind-changed tack)
- Overlapped
- Seventeen (overlap established from clear astern within two length)
- Clear
- Zone (combined with 'clear' or 'overlap')
- Changing course

Most of these terms are too lengthy to be concise, so umpires can substitute a short and sharp word like NOW (or even DONE) at the appropriate moment. Examples of instantaneous calls could be:

'Zone call coming up..... NOW!'

More efficient calls - and how to avoid misunderstandings

The umpires should confirm the way they will be calling different situations before they start umpiring together. The following system is very efficient, but both umpires need to be aware that calls are instantaneous and apply from the moment the umpire state the new situation.

In several scenarios there are various pieces of information that need to be stated. For instance when boats meet in a slam dunk situation; Exactly when the tacking boat passes head to wind, the umpire will call 'tacking', and the moment the tack is complete the umpire need to communicate that the boat is no longer a tacking boat, it is now port or starboard, and finally, whether or not there is an overlap.

The moment the tack is completed, the umpire may call 'clear', meaning: My tack is completed, we are on the same tack and there is no overlap.

If the umpire calls 'windward' it is clear that the boats are overlapped on the same tack at the moment the tack is completed.

In a tight tacking duel, the most efficient call is 'starboard' or 'port' - replacing: 'Complete, Starboard' or 'Complete, Port'.

The same principle is used when the boats are gybing..

D.13 Wing Umpires

Good wing umpires are very valuable and can strongly influence the outcome of a call. E.g. 'overlap' or 'clear' at the zone.

Wing umpiring is an onerous and demanding task, and driving a wing boat is normally more of a challenge than driving an umpire boat. Its importance should not be underestimated, and high-calibre people should be assigned to the duty when it is not part of the duties of the umpires at the event.

If umpires are available to perform the duty, they should be used. They are usually available during the final series when there are fewer matches in progress. Umpires must expect to be assigned wing umpire duties. At most events today all the functions of the umpiring team are performed by umpires.

Sailors with good rules knowledge can also be effective, and they soon appreciate the objectives of the umpires.

When acting as a wing umpire one should be referred to as Wing and not Umpire. They are not decision makers but providers of facts. They are the umpires' extra pair of eyes, reporting what they see, but usually not giving opinions unless opinions are asked for by the umpires of that match.

As wing umpires are an integral part of the umpiring team, they must be in attendance at umpire meetings.

When an umpire pair is used as wing umpires, they should have all equipment necessary for umpiring in the wing boat, and be ready at all times to step in as a reserve umpire in case anything happens with any of the other umpire pairs.

The system used when there are no 'extra' umpires or wing umpires is that Umpire 2 wing for Umpire 1 in the pre-start, and then Umpire 3 wing for Umpire 2. With this system, there will be no wing for the last match in the flight. When the RC boat is also the starting mark they would normally be willing to assist the umpires in the last match with calling the perpendicular for the Yellow boat at the entry.

When Umpire 1 finishes their match, they will look around, to see if any of the other matches need a wing - or they may call their availability on the radio.

The functions and duties of wing umpires are described in Part G in this Manual..

D.14 On Board Observers

Since 1990, on-board observers have been used at some major Match Racing events. Instead of, or in addition to wing umpires, observers can be placed on the stern of each boat to signal information back to the umpires.

Observers have the advantage of being very close to the action, always in position to give correct calls on overlaps and also to give information about contact between boats or contact with a mark.

Other advantages are:

- (a) They are never out of position. A wing umpire often has difficulties maintaining a position to call overlaps with certainty.

- (b) The wing boat does not need to follow the match; it can be positioned to watch the perpendicular when the boats enter and at a mark to call the zone.
- (c) The umpires have an immediate independent contact on the boat to assess what help is needed for breakdowns, which may save time.
- (d) The observers are in good position to be independent witnesses for protests regarding boats and equipment.
- (e) There are fewer boats within the course area during racing, and therefore less wake.

The major disadvantage with on-board observers is:

It is sometimes difficult for them to determine when a boat enters the zone.

Other disadvantages are:

- (a) Observers cannot always signal distance between boats.
- (b) It can be difficult to transfer the observers on or off the boats in rough weather.
- (c) Experienced crew may be able to pressure young observers and so influence their signals.
- (d) Observers must be paired, and their weights equalised.
- (e) Not all boats are suitable for observers.
- (f) More personnel are needed than with the wing umpire system.
- (g) The boats may need to be specially adapted at the stern to accept observers and enable them to escape into the cockpit if safety requires.
- (h) There can be danger of physical injury to an observer standing outside the stern. Apart from the human factor, legal liability and insurance may be a consideration.

The observers may get on the boats before they leave the harbour, or they may be put aboard by the umpires shortly before the preparatory signal. If the boats do not go to the harbour between flights, the umpires can transfer the observers. A safe procedure is essential for this. It is recommended that the observers do not stay with one team.

As observers are an integral part of the umpiring team, they should attend the umpire meetings. The functions and duties of the observers are further described in Part G in this Manual.

D.15 Penalty Signals

A penalty signal consists of two parts - the sound and the flag. The sound signal comes before the flag, for the sound means in effect 'The decision is about to be announced'.

The umpires will also display one flag (or one shape) for each outstanding penalty. The flags/shapes will be of corresponding colours to the ID flag of the penalized boat.

A whistle has been found to be the most efficient sound signal, and it should be blown sufficiently loud and long to draw the attention of both the boats, plus spectators and other interested persons.

Sometimes the Race Committee uses a whistle as one of its sound signals, and in this case the umpires sound can be distinctive by making the signal even longer. (Should this cause

confusion, another possibility is to change rule C5 to allow two long blasts from the umpires when signalling to give a decision.)

The flag must inform both competitors and the spectators of the decision, so it must be displayed prominently. It is recommended that the signal be held aloft for not less than ten seconds. When a flag is first displayed, there will be some people whose view is obscured by sails or other obstructions. During the ten seconds the umpire boat should have moved sufficiently for everyone to see the decision. Umpiring should continue uninterrupted while the flag is being held up.

With a single penalty, it is good practise to avoid signalling just as a boat is rounding a mark. If boats are in a tight manoeuvre, a short delay in the signal may be appreciated by the sailors.

With a red-flag penalty or a second penalty the umpires should delay signalling when the boat to be penalised is approaching a mark and cannot take the penalty before the mark without risk of fouling its opponent or getting into the zone while taking the penalty. At a top mark it is preferable, but not always possible, for the umpires to signal such a penalty before the penalised boat hoists the spinnaker, because a late signal will severely increase the penalty.

Mistakes by umpires in displaying flags cannot be corrected, see MR CALL M1 and L1. The potential for error can be reduced if the umpire who displays the signals always grabs the flag by the cloth instead of the stick. If a third person is driving the umpire boat, only the umpire who has adopted the blue boat will display the blue flag, and the yellow flag is displayed only by the other umpire. Coloured tape around the stick of the flag, in the same colour as the flag, is also very useful.

The umpires must signal the moment a penalty is completed (one short sound signal), as that is the moment when the boat taking the penalty gets her rights back. (Rule C5.5) The umpires then remove the penalty flag/shape.

When a boat taking a penalty fails to take the penalty correctly or does not complete the penalty as soon as reasonably possible, the umpires will give several (at least four or five) short blasts with the whistle to signal that it is no longer taking a penalty (Rule C7.4(b) and C5.6. It is very important that this signal is given the moment the umpires are convinced that;

- the boat has passed head to wind with the top of the spinnaker above the main boom goose neck (when the penalty is to tack) (Rule C7.3(a)),
- the boat has entered the zone of a rounding mark while taking the penalty (Rule C7.3(b)), or
- the boat does not complete the penalty as soon as reasonably possible (Rules C7.2(a)(1) and (2)).

The precise moment when the umpires signal that a boat is no longer taking a penalty is the moment when the boat that was taking the penalty gets her rights back.

Many competitors will start hoisting the spinnaker again once the boat is on a close hauled course, and the umpires must watch carefully to see that the head of the spinnaker is not above the main boom gooseneck until after the boat is on a close hauled course (Rule C7.3(a)).

When the umpires decide to penalise both boats after an incident (twin penalty), they should try to signal both penalties at the same time. (Blow the whistle and hold up both the blue and the yellow flag.)

The black flag should be stowed well away. It is preferable that a decision to black-flag a competitor should be made only after an in-depth discussion between the umpires. There is no need to rush this signal and the extra time taken to get the black flag provides a further safeguard. The Chief Umpire will often require that he or she be contacted before any black flags are given. The exceptions to this would be when one of the boats gets her third outstanding penalty, does not take her second penalty as soon as reasonably possible, or in accordance with C8.5 when the umpires are satisfied that one boat will not start. The umpires should not display the black flag when one of the boats is being recalled but chooses to continue sailing instead of returning to start.

In an incident involving boats in different matches, the two umpire pairs should attempt to discuss the case before making a decision. One umpire pair should avoid signalling a penalty to a boat in the other match. If only one of the umpire boats is nearby, and the boat in the other match is to be given a penalty, the signalling of the penalty may be delayed until the other umpire boat is nearby. When this is not at all practicable, the umpires may signal a penalty to the boat from the other match, but must make it very clear to everybody which boat is being penalised. (There may be two yellow boats involved.) The penalty flag/shape should ALWAYS only appear on the correct umpire boat.

The umpires may signal a red-flag penalty when the boat that broke a rule gained a controlling position because of the breach - but the umpires are not certain that requirements for an umpire initiated second penalty is met (rule C6.5(b)). The red flag could be signalled simultaneously with the ID flag or by itself shortly after, when the umpires realise that the boat has gained a controlling position. A red flag signalled without any other flags (with a whistle) always refers to the most recent penalty signal.

Note that if the other boat has an outstanding penalty, the decision to give a red-flag penalty must be immediate. Once the penalties have been offset, you can no longer signal a red-flag penalty.

If the umpires have already given the penalty, and then decide it should have been a red flag penalty they must be very careful not to show another penalty flag with the red flag. If a blue or yellow flag is shown with the red flag that is displayed after the penalty flag, it actually imposes another penalty on the Blue or Yellow boat! A document that also describes umpire actions in penalty situations can be found at the end of Part.

D.16 Umpire More Consistently

Another contribution to improve our umpiring is to strive for consistency. The aim is to provide the competitors with the same call for the same situation. The figure below illustrates at the top how decisions may vary in a certain situation like the luffing maneuver illustrated in Figure 2 (D 11 in this Manual). If Blue reacts too slowly she will be penalised. On the other hand, Yellow will be penalised if she luffs too quickly. In between, there is a “grey” area where we have difficulties deciding who should be penalised, and, therefore, we wave the green flag.

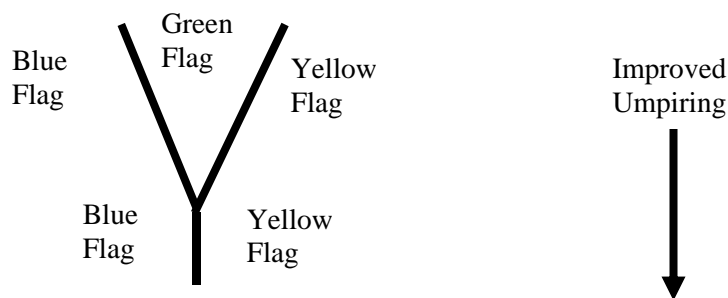

As our umpiring is improved, the 'grey' area will gradually shrink. And we can imagine that one day we never have to wave a green flag in this situation; we give either a blue or yellow penalty. At the same time, we may expect the competitors to improve their sailing so they can drive it right to the edge. With this development we end up in a position where we may decide to give a blue penalty in a certain situation, but with just a tiny change in the maneuvering of any of the boats we give a yellow penalty instead. We arrive at the paradox that seen from the outside, the penalties given in match racing seem more and more random as competitors and umpires improve their skills. Such a development clearly contradicts the ambition of making umpiring more clear and consistent.

In order to avoid this development, we should in certain situations penalise both boats, a Twin penalty. (A double penalty is two penalties on one boat) In doing so, we get an intermediate area where we decide that both boats have broken a rule. This development in our umpiring can be illustrated this way:

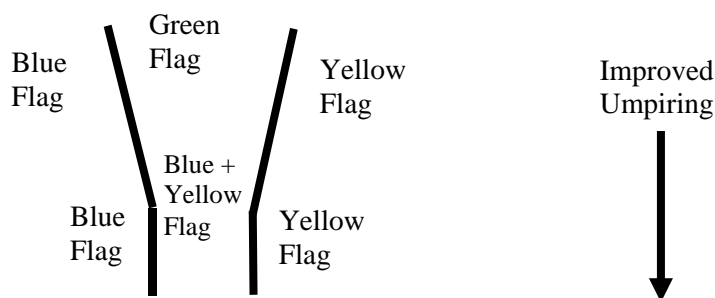

With a luffing maneuverer like the one illustrated in Figure 2 (D 11 in this Manual), there may be occasions where we decide that the contact occurred both because Yellow luffed too quickly and because Blue responded too slowly. A green flag in this situation may be misinterpreted to mean that no rule was broken, whereas our decision in fact is that both boats broke a rule. We can signal this decision by waving both the yellow and blue flag. Considering penalties, it makes no difference, but we clearly communicate to the competitors that they are inside the 'grey' area. When there is clearly contact between the boats, somebody should be penalised. If the umpires cannot decide, after using all the general principles for umpire decisions, they should consider penalising both boats.

D.17 Signalling

A quick reference form for match racing protests; 'Who protests - how - for what', can be found at the end of this Part of the Manual.

(a) Signals from Boats to Umpires

Arm signals (from helmsmen only) are covered in Part E 23 of this Manual.

Y-flags must be displayed clearly. See also E 29 of this Manual.

Red flags from boats are covered in Part D 20 of this Manual.

(b) Signals from Umpires to Boats

Flag signals are covered in RRS Appendix C, and D 15 of this Manual.

If an umpire-initiated penalty is given for touching a mark (rule 31), the crew may be advised by an umpire patting the top of his own head with his hand.

If an umpire-initiated penalty is given for illegal propulsion (rule 42), the crew may be advised by an umpire making a pumping action with one hand moving vertically up and down.

(c) Signals from Wing Umpire to Umpire

When radios are not being used, wing umpires (and on-board observers - see Part G) use standard arm signals:

- i) **Affirmative** - arm raised vertically above the head. The umpires will understand this to mean there is an overlap.
- ii) **Clear** - arm held out horizontally. The umpires will understand this to mean there is no overlap.
- iii) **Contact** - patting the top of head with a hand. The umpires will understand this to mean the wing umpire has seen contact between the boats, or between a boat and a mark.
- iv) **Unclear situation** - no signal. The umpires will understand this to mean the wing umpire is unable to give accurate information. (For example, the boats have been overlapped when the windward boat luffs and the wing umpire is not in accurate position to determine if the overlap is broken.)

Wing umpires must make sure the umpires can see the signals, and that there can be no confusion. (For example, an arm extended to hold on is not misunderstood as a 'clear' signal).

Wing umpire signals and functions are further covered in Part G of this Manual.

D.18 Umpire and Wing Boat Positioning

Umpire boat positioning is further described in Part F of this Manual.

The first priority for the placement of the umpire boat is to achieve the best view of a potential incident. The competitors must accept that this will, at times, create wash or turbulence or other disturbance to a boat. At other times when placement is not so critical, the umpires should endeavour to keep their boat's disturbance to the minimum. Umpires should appreciate that in the competitors' perception, such disturbance may occur long before the umpires think it does.

Upwind	Do not position abeam and to windward so that if the boat tacks towards you, you must escape quickly leaving disturbed water. If one boat is well ahead, do not take up position where your wash affects the trailing boat.
Downwind	If watching for an overlap, go to windward, but do not move in so close that your wash affects the trailing boat.

	Do not position directly upwind of a boat. This may disturb the boat's wind (or the crew may suspect it does). Move if the boat's masthead wind indicator is pointing at you.
Marks	Be careful when in the 'forbidden V's' which are discussed in Part F of this Manual.
Noise	Do not follow close astern of a boat except when necessary. Your engine noise can be a distraction. Do not leave your radio on full volume when not required. In light weather, keep your voice down to a level which will not carry to the boats.
Crossing	Never pass between the two boats of a match except occasionally in the pre-start. If correct positioning techniques are being used, you will find this need should not arise.
Other Matches	These same principles apply to the boats in the other matches. Be aware of all the boats. Look behind regularly to check you are not affecting a boat in another match.
Wing Umpire	Ensure your wing umpires are also aware of all this. If you see them causing disturbance, then draw it to their attention.

It is a good idea to observe your wash before the first match of the day. Discuss its effect at different speeds and in different sea conditions. Take particular note of the distance it travels, and its effect, in flat water.

D.19 Visitors on Umpire Boats

Umpire boats are not spectator boats, and no extra people should be aboard if the umpires are uncomfortable about it.

However, if both umpires agree, visitors could be allowed on umpire boats, providing it is first explained to them that it is essential they comply with all instructions the umpires may give.

Umpires should also explain that as visitors they will overhear private conversations of the umpires, and what they hear must remain confidential.

To allow umpire trainees to go on the water as observers with experienced umpires is strongly recommended. Often event sponsors will also appreciate the opportunity to get out on an umpire boat.

There may also be requests from media to come on the umpire boats. This provides the most spectacular view of the racing and it happens quite frequently at principal events.

Umpires should not accept visitors on umpire boats when they find that the extra weight has a negative impact on the boats manoeuvrability.

D.20 Red Flag Protests

If a boat finishes a match displaying a red flag, then the umpires should ask the nature of the protest. This is not the time to take any evidence. The umpires give the information to

the Chief Umpire (or protest committee/jury chairman) who will decide who will hear the protest and where and when it will take place. The boats involved must then be informed.

At principal events, it is quite common for the Chief Umpire to ask Umpire 1 to act as Chairman of the Protest Committee/Jury in order to speed up the procedures. Umpire 1 may then start to investigate whether or not the protest or request is valid, and then immediately start the hearing when that is required. This may happen while the last matches in the flight are still racing.

Should the red flag involve a request for redress because of circumstances that arose before the boat finished or retired, the flag must be displayed immediately, but no later than two minutes after finishing or retiring.

Whether or not the protest or request has any substance, the sailor that requests a hearing always have the right to one. If the protest or request is invalid or with no substance, the hearing will be short, but they can never be denied a hearing.

Protest hearings can be held aboard a suitable boat, which could be a spectator boat, a Race Committee boat or an umpire boat. They may also be held by 'rafting up' some umpire boats and even the boats concerned, although this usually means there will be a number of onlookers listening in to proceedings. Radio discussions should be avoided.

If one of the boats in a match requests redress because of procedural matters (e.g. late recall) or the conditions on the water, it is important to always include the other skipper as a party in that hearing.

Due to the simplified procedures permitted by Appendix C, a speedy decision can be made on-the-water or ashore.

If it appears that an on-the-water hearing may cause a considerable delay in the racing programme, it may be an option to delay the hearing until after the last flight of the day.

A delay can sometimes provide another advantage. If further flights are held before the hearing takes place, it may be that the overall result is not affected regardless of the protest decision. (A protest win will not move a competitor further up the ladder, or a loss further down the ladder.)

As the possibility exists that there may be a red-flag protest in the last match of the last flight of a day, the Chief Umpire may instruct the umpires to stay afloat until the last match finishes.

D.21 Umpiring Team Assignments

Making the umpire pairs that will do the umpiring on the water is a key task at a match racing event. The challenge is to provide the best possible team combination with the umpires that are present. It is easy to take the two most competent and experienced umpires in the team to form a strong pair. But the question is where that leaves the rest of the team. A good set of umpire pairings for an event must take these factors into consideration:

- Different levels of experience / competence
- Feeling of being appreciated
- Enhancing consistency in calls
- Development and assessment of new umpires

- Conflict of interest
- Personal relationships

When one is facing the task of making umpire pairings, it is highly relevant to focus on the competence of different umpires. Our aim should always be to pair umpires in a way that provides the best service to the competitors. However, this may not be achieved if we focus solely on competence. We also have to consider the other factors above.

The feeling of being appreciated is important. Challenges are necessary for developing one's competence. So a task that is too easy is not desirable. For example, most umpires would probably be disappointed if they were asked to do wing/observing for a whole event. On the other hand, challenges must also be realistic.

The typical set of umpire pairings is based on some form of rotation. During an event or part of an event each umpire rotates in the sense that he or she works with most of the other umpires. Rotation is a good idea for several reasons. First of all, it enhances consistency. If a couple of umpires work together all the time, they may develop their own interpretations. Secondly, rotation enables less experienced umpires to learn from being with more experienced ones. If the group of umpires have clearly varied levels of experience, development is a key factor. Thirdly, assessment of umpires is important both for the event and for the development of all umpires. When an umpire works together with several other umpires, a richer evaluation of the competence of that umpire should be achieved.

It may be necessary to avoid certain combinations of umpires and competitors. One reason for this is if there is a conflict of interest because of nationality, financial dependence or some other similar relationship. There are also examples of situations where certain umpires want to avoid umpiring matches with a specific competitor. It is highly desirable that conflict issues are discussed with the Chief Umpire. The point made here is that before making umpire pairings, it must be decided at each event how to handle potential or actual conflicts of interest.

It may also be argued that certain combinations of umpires should be avoided, e.g. due to negative personal relationship. This should not be accepted as a relevant condition. The ability to work with any other umpire and forget personal relationships is an important quality of a serious umpire.

It is a duty of the Chief Umpire to 'pair' the umpires and allocate boats, drivers and wing umpires. A good system is to make 'Umpiring Team Assignments' sheets and distribute them to the team. The Chief Umpire may decide to delegate this job. One rotation per day is recommended. At the end of this part of the Manual, you will find some examples of umpire pairings.

D.22 On Shore Duties

So as to ensure smooth running, it is recommended that the Chief Umpire allocate specific on-shore duties to the umpires. This will often happen at the first briefing of the umpiring team, or sometimes even before the event by email.

Each event may differ, but below is one example, where the two umpires are responsible for all the tasks on the list - and they share the tasks between them.

- Check the notice board
- Put umpire flags and identification flags on board

- Confirm boat has fuel
- Pick up radio and check its operation
- Ensure lunches and drinks go on board
- Hoist your identification flag
- Decide who will use the radio
- Decide who will drive the boat or direct the driver
- Ensure adequate sound and flag signals are made from your boat
- Ensure speedy change-over occur on the water
- On return, take down identification flag and help the driver secure the boat, clean up and remove trash
- Ensure the boat will have adequate fuel for the next day
- Return radio and make sure it is put on charge
- Ensure report forms are completed if required
- Be on time at the post race debriefing.

Some Chief Umpires prefer to have a list where the tasks are already distributed between the two umpires.

D.23 Incident Report Forms

At some events, the Chief Umpire may ask umpires to complete an 'Incident Report Form' for each Y-flag incident or for incidents that may be of general interest. These forms are useful for later discussion and for statistical analysis. Studies can show which rules and situations are giving the greatest problems, or where particular competitors or umpires may be experiencing difficulty with a rule.

Making incident reports after racing can be very valuable for training purposes. An event like the America's Cup uses incident report forms based on TSS diagrams.

Incident Report Forms can vary in their presentation, and two examples are included at the end of this Part of the Manual.

D.24 Explaining Decisions to Competitors

Umpires must be willing and available to explain their calls to the competitors. The time for explanations can be:

- (a) At the umpires' post-race debriefing meeting. The competitors should be advised of the time and place of these meetings and be invited to attend and hear the explanation.
- (b) Ashore after racing, for example on the dock or in the bar.
- (c) On the water at the conclusion of the match. Umpires should be aware that emotions may be running high at the end of a match and it may be best to wait a couple of minutes before conversing with the crew. At times it will be preferable to advise the skipper 'See us when ashore'. Note that whenever the sailors call you over, you must check with them. There may be another reason why they are calling your attention... for instance an injured team member.

Explanations should be restricted to giving the reason for the call, for example 'We considered you had no need to change course to avoid the port-tack boat'. Any rational

discussion on the applicable rules and 'what if?' questions should be answered, but umpires should not enter into any argument concerning the facts. Giving reasons for calls should promote good umpire/competitor relationships, but any head-to-head argument over the correctness of a call will damage those relationships.

Informal discussions between competitors and umpires provide a good way of developing the game of match racing, as both parties usually have something to learn from each other. It is of equal importance to respect the other party's point of view.

D.25 One on One communications with competitors or rules advisors

It is important that umpires are not seen as being too close to individual competitors by spending too much time with one skipper, a particular crew, or a coach or rules advisor representing one team. One obvious way to prevent this is to ensure you are in the company of others when meeting with competitors.

It is important to make it clear to competitors that you are giving your opinion only and not necessarily that of the whole team. If you are unsure of an answer you are giving then refer this to the rest of the umpire team or ask the competitor to raise it at the next debriefing session.

If as a result of your further discussions you become aware that you may have given a wrong or misleading interpretation then you should go back to the competitor and revise your response to ensure there are no misunderstandings.

D.26 Explaining Decisions to the Public

Depending on the policy agreed by the umpire team, umpires should be willing to explain the reasons for any call to media representatives, but avoid any dispute.

Umpires will at times be asked to give explanations for their decisions by radio during the match. If umpires agree to provide this service, it is extremely important that those explanations be delayed until the boats have separated and there is a lull in the umpiring. Umpiring must take first priority and there should be no break in concentration while an umpire makes a radio transmission or thinks about what he should say.

It is, however, for the benefit of the sport that event speakers are able to give the correct information to the audience. There are also circumstances where media would already have given a wrong explanation of a call before the umpires get back ashore and can explain their decisions.

D.27 Press Conferences and Individual Meetings with the Press

Usually only the Chief Umpire is asked to attend the press conference, but occasionally an umpire involved in a particular incident may be asked to attend. Competitors sometimes use these sessions to be critical of a decision that has not gone their way.

It is important not to get involved in a discussion with the competitor in front of others. It is best to only make general comments about the days racing. Ensure that you listen to any questions, and try to answer them as reasonably as possible. Do not get irate.

The press are more frequently trying to get direct information from umpires. Usually these interviews are directed to the Chief Umpire and if the press approaches a member of the

umpire team for a comment on an incident it is prudent to refer the matter to the Chief Umpire.

Be careful not to make any comments that are critical of either the Competitors or the umpires as these will almost certainly be published and may cause difficulties later.

BRIEFING CHECK LISTS - UMPIRE & JURY TEAM

Introduction:

Welcome
Umpires and Judges – names
Introduce organizers, race officer, boatman, etc.

Jury/Judge responsibilities for delegation:

Organising Committee link
Race Committee link
Umpire team assignments
Umpire boats
Equipment (including ID-flags on umpire boats)
Observers
Clothing
Damage
Meals
Transport
Social
Accommodation
Expense claims
Scenario write-ups
Questions and Answers

Daily Routines and Procedures:

Transport to/from accommodation
Start time and umpire briefing/assignments
Leave dock
Umpire debriefing
 Lunch & Water
 Fuelling
 Equipment storage
Medical emergency procedures
Red-flag protests
Post race reports, Y-flags, Penalties, Green-and-White, and Blacks

Social:

Events and dress codes
Evening meals
Opening and Closing events
Other events

Personal:

Accommodation
Transport & Car Parking
Expense claims
Medical, anything the whole team should know

Passes, or identity cards
Personal Floatation Devices

Press/Media:

Attend conferences
Policy on speaking with media

Sailing Instructions & Notice of Race:

Event format
Course location and configuration
Damage notification and control (including deposit system)
Penalty system
Rules for Handling the Boats

Umpire equipment:

Boats
Mooring
Radios
Channels
Re-charging
Storage
Flags, shapes and shape display
Telephones
Umpire techniques:
Positioning
Characteristics of the boats
Signalling penalties
Loss of umpire boat/equipment/engine failure
Communicating decisions to the shore
Wing Boat techniques:
Wing boat calls on the radio
Positioning
Loss of wing boat

Observer techniques:

Observer signals and Observer duties

Race Committee:

Umpire/Observer readiness to start
Recalls
Umpire foul-ups
Monitoring umpire radio
Calling outstanding penalties
Calling breakdowns
Red-flag protests

Competitors:

First briefing
Morning briefing

Daily debrief with umpires
Talking to competitors
Questions and Answers (formal and informal)

BRIEFING CHECK LISTS - UMPIRE/RACE COMMITTEE

INTRODUCTION:

Introduce Umpires and Judges to the Race Committee

JURY/JUDGE RESPONSIBILITIES:

Race Committee link

Daily Routines and Procedures :

Meeting with RC

- evening debrief
- morning meeting
- amendments SI

Competitors debriefing and briefings

RC's intentions regarding the racing schedule (e.g. planned number of flights per day).

Sailing Instructions & Notice of Race:

Event format

Course location and configuration

Damage notification and control

Penalty system

Handling the boats

Procedures should it not be possible to complete the full racing programme.

COMMUNICATIONS:

Radio: umpire channel

Readiness to start

Failure to cross the starting line

Outstanding penalties before finishing - umpires whistle

Black flags

Breakdowns

Red-flag protests

Umpire foul-ups

Mobile telephone

The Course

Location - spectators, proximity to obstructions

Starting line - length, bias, ground tackle

Course length, bias

Time limits – none

Restricted areas

Signals

Starting sequence

Boats not complying with pre-start entry

Recalls - Blues/Yellows on sticks - see C 3.2(b) and (c)

AP and N - always followed by attention signal

Change of course - during start sequence and subsequent changes

- Shortening course - but not after preparatory signal unless it is the only way to have a winner in the entire regatta

Abandonment - criteria for

General recalls – never

Finish

General

Discussion on any problems umpires have encountered at other events, and which could occur again, and procedures to be put in place should they arise. Procedures for on-the-water protest hearing.

UMPIRING TEAM ASSIGNMENTS

In these descriptions, the chief umpire is always numbered as umpire 1 and the deputy chief umpire or chairman of the protest committee or jury is umpire 2.

Pairings Based on One Group of Umpires

When all umpires are on a comparable level of competence, and thereby forms one coherent group, pairings can be made by means of the list that are used for pairings crews. For example, if we have 6 umpires and three matches, we can make the following pairings:

	Pairing 1	Pairing 2	Pairing 3	Pairing 4	Pairing 5
Match 1	2-5	2-4	2-3	2-6	4-6
Match 2	3-4	3-6	5-6	4-5	3-5
Match 3	1-6	1-5	1-4	1-3	1-2

Pairings Based on Two Groups of Umpires

It is most common to have a varied group of umpires. In that case, we can divide all umpires into two groups: experienced and less experienced. The idea then is to rotate umpires in each of the two groups and pair them with umpires from the other group. For example, we may have an event with 2 umpires who are more experienced (1 and 2) and 4 who are less experienced (3 to 6), and there are 2 matches in each flight. The two most experienced umpires do either of the matches and the other four rotate. With these conditions, we can make the following pairings:

	Pairing 1	Pairing 2	Pairing 3	Pairing 4
Match 1	2-3	2-6	2-5	2-4
Match 2	1-6	1-5	1-4	1-3
Wing	4-5	3-4	3-6	5-6

A similar situation is where there are 3 very experienced (1 to 3) and 5 less experienced (4 to 8), and there are 3 matches in each flight. This set of umpires can be paired the following way:

	Pairing 1	Pairing 2	Pairing 3	Pairing 4	Pairing 5
Match 1	2-5	2-4	2-8	2-7	2-6
Match 2	3-4	3-8	3-7	3-6	3-5
Match 3	1-8	1-7	1-6	1-5	1-4
Wing	6-7	5-6	4-5	4-8	7-8

If there are only 6 umpires divided in two groups (1 to 3) and (4 to 6), there will be no wing umpire. In that case, we can make the following pairings:

	Pairing 1	Pairing 2	Pairing 3
Match 1	2-4	2-6	2-5
Match 2	3-5	3-4	3-6
Match 3	1-6	1-5	1-4

MATCH RACING INCIDENT REPORT FORM 1

Please circle where applicable

Date :

Flight: : 1 2 3 4 5 6 7 8 9 Match: 1 2 3 4 5

During : Round Robin 1 Round Robin 2 Semi Final Final

Umpires : and

Helmsmen : (BLUE) versus (YELLOW)

Y-Flag was flown by : BLUE YELLOW BOTH BOATS

Decision signalled: GREEN and WHITE (RED) BLUE (RED)YELLOW BLACK

Rules(s) applicable :

Brief description or diagram of the incident:

Comment (if any) on the crew's reaction, opinion or follow-up discussion:

This form was completed by:

UMPIRE

MATCH RACING INCIDENT REPORT FORM 2

Round : _____ Flight _____ Match _____

Event Title:

Date:

Competing Boats:

Umpires:

Y-Flag/red flag from which boat:

Wing Umpire signal:

Decision signalled by Umpires:

Rule(s) Judged Applicable:

Incident (description/diagram):

Debrief:

Author:

MATCH RACING PROTESTS

Who protests - how - for what ?

By a boat..... using a Y-flag..... against another boat [C6.1(a)]

A rule of Part 2, including
Not keeping clear while taking a penalty [22.2]
Interference from a boat not racing [C2.9]
Interference when taking a penalty [24.2]
Interference on different legs [24.2]
Interference from a boat in another match [C2.11]

BUT NOT : for Rule 14
AND ONLY : if involved in the incident

By a boat..... using a red flag..... against another boat [C6.1(b)]

All rules and sailing instructions, including rule 14 when damage results
EXCEPT: The Y-flag matters (as above)

Touching a mark [31]
Propulsion [42]
Incorrect position at preparatory signal [C4.1]
Not crossing the start line from the course side correctly [C4.2]
Not taking penalties correctly [C7]

By the Umpires..... shall give a penalty: [C8.2]

Touching a mark [31]
Propulsion [42]
Incorrect position at preparatory signal [C4.1]
Not crossing the start line from the course side correctly [C4.2]
Not taking a second penalty (or red-flag penalty) as soon as reasonably possible [C7.3(c) and (d)]

By the Umpires..... shall give a red-flag penalty

When the boat that broke a rule has gained a controlling position as a result of breaking a rule - and the umpires are not certain the conditions for an additional penalty have been fulfilled. [C6.5(b)]

By the Umpires..... may give a penalty OR a black flag

Gained an advantage by breaking a rule after allowing for a penalty [C8.3(a)]
Deliberately broken a rule [C8.3(b)]
Committing a breach of good sportsmanship [C8.3(c)]

By the Umpires..... shall give a black flag

If a boat has more than two outstanding penalties [C7.2(f)]

By the Umpires or Protest Committee.... through a hearing [C8.4]

All rules and sailing instructions

EXCEPT: The Y-flag matters (as above)
Matters which umpires can penalize on the water (as above)

Umpires may black flag a boat after her opponent has started when they are satisfied that she will not start. [C8.5]



INTERNATIONAL UMPIRES' AND MATCH RACING MANUAL

SECTION E

Umpiring Scenarios

Contents		Page
E	Umpiring Scenarios	
E 1	Position at the Preparatory Signal, First Cross	E 2
E 2	Entering the Pre-Start Area	E 2
E 3	Close-Hauled, Particularly after Tacking	E 2
E 4	Tacking and Gybing	E 3
E 5	Head to Wind	E 3
E 6	Room to Keep Clear	E 3
E 7	Fish-tail	E 4
E 8	Approaching the Starting Marks	E 4
E 9	Close Tacking	E 4
E 10	Slam Dunk	E 4
E 11	Dial down	E 4
E 12	Proper Course	E 5
E 13	Sailing above Proper Course Downwind	E 5
E 14	Overlaps	E 6
E 15	Marks - Room at Marks – Mark-Room	E 6
E 16	Touching a Mark	E 8
E 17	Passing Obstructions	E 9
E 18	Room at Continuing Obstructions	E 9
E 19	Illegal Propulsion	E 10
E 20	Finishing Line Incidents	E 11
E 21	Damage from Contact	E 11
E 22	Incidents with a Boat in Another Match	E 12
E 23	Arm Signals	E 12
E 24	Gaining an Advantage	E 13
E 25	Deliberately Breaking a Rule	E 13
E 26	Gaining a Controlling Position – Red-Flag Penalties	E 13
E 27	Good Sportsmanship	E 14
E 28	Other Umpire-Initiated Penalties	E 14
E 29	Y-Flag Displays	E 14
E 30	Taking Penalties	E 14
E 31	Incorrect Penalties	E 15
E 32	Wing Boat Signals	E 15
	7 questions about approaching obstructions in the pre-start	E 16
	Notes to Umpires about Damage Procedures	E 21

A number of the common situations when an umpire will be called upon to exercise his judgement are discussed in this Part. Far more scenarios are covered in the Call Book for Match Racing, and umpires should study the Call Book in detail so they have no hesitation in making the appropriate decision in those circumstances.

E.1 Position at the Preparatory Signal, First Cross

Rule C4.1 requires a boat to be positioned outside her designated end of the starting line at the preparatory signal.

Only the umpires can initiate a penalty when a boat breaks this rule (not the other boat or the Race Committee). It is the umpires' responsibility to check this and act under rule C8.2 when required. It is difficult to sight with accuracy a line perpendicular to the starting line, so unless the umpires can clearly see that the rule has been broken by a boat crossing that line too early, they should not take any action.

The umpire boat should be stationed under the pin end as the boats enter, and the wing boat will be stationed to windward of the RC boat. Without a wing boat, the umpires will cover this position for each other, leaving only the last match without a wing. When the RC boat is also the starting mark, the PRO (Principal Race Officer) may accept to check the perpendicular for the last match when requested. The RC boat will then inform the umpires of any early entries and the umpires will signal a penalty on the boat that entered early.

A separate sheet with seven First Cross scenarios is attached at the end of Part F of this Manual. The sheet includes the preferred umpire positioning for each scenario.

E.2 Entering the Pre-Start Area

The Race Committee will be watching the boats make their first crossing from the course side to the pre-start side of the starting line (rule C4.2).

If a boat has not crossed the starting line correctly in time, the Race Committee will make a sound signal and display a blue or yellow flag or both. The umpires must then penalise the boat(s) under rule C8.2.

E.3 Close-Hauled, Particularly after Tacking

Throughout the match the umpires will be called upon to decide a close-hauled course. As this is a subjective judgement, the umpires should watch boats tacking and sailing close-hauled, then discuss and agree this course even before the start of the match.

Before the starting signal, deciding close-hauled will be necessary only when one or both boats tack, because at this moment rights and obligations change. After the starting signal it may, in addition, be a question of proper course on the beat when an overlap has been established from clear astern within two lengths of a windward boat.

Finally, a boat taking a penalty while sailing to a windward mark completes her penalty and gets her rights back the moment she gets to a close-hauled course. At that precise moment, the umpires must give a short sound signal to advise that the boat has completed her penalty, and that the rights and obligations may have changed (rule C5.5). The umpires must also remove a penalty flag/shape.

E.4 Tacking and Gybing

Rule C2.4 (rule 13) have the effect of getting the definition of Gybing back into the rulebook for match racing. A boat must keep clear from the time the foot of the mainsail crosses the centreline, until the sail has filled or she is no longer sailing a downwind course.

Pre-start manoeuvring as well as downwind sailing may involve a lot of gybing. With this rule, the gybing boat needs much more room to be able to gybe in the pre-start, and the sailors are using different techniques to help the mainsail fill as quickly as possible after a gybe. The umpires must be convinced that the sail is filled or the boat is no longer sailing downwind before the boat gets its rights back. It is possible, however, for a sail to be filled even with the top batten still reversed. As rights and obligations change during these scenarios, instantaneous calls are essential (see D12). See also the Call Book for Match Racing.

Rule C2.4 also addresses the rights and obligations between two boats that are subject to rule 13 at the same time. 'The one on the right is right' applies between two boats tacking and/or gybing – and if the boats are not overlapped the one astern has to keep clear.

E.5 Head to Wind

It is not wise for umpires to attempt to be too strict in their judgement of head to wind, because they may be given false indications such as:

- genoas may back before a boat is head to wind
- masthead indicators are influenced by the sway of the mast
- the crew may roll the boat before reaching head to wind
- wave direction and wind direction may not be parallel

Unless the umpires are very sure, they should rule that a boat has not passed head to wind. (See Call Book, General Principles for Umpire Decisions)

E.6 Room to Keep Clear

Pre-start luffing is always allowed when there is space available for the windward boat to respond. Even a quick luff by the leeward boat will be within the rules, provided the windward boat can avoid the leeward boat by manoeuvring promptly in a seamanlike way. The umpires need to consider whether the windward boat initially kept clear, whether there was room available and whether she manoeuvred promptly.

As 'initially' also comes into play with rule 15, it becomes a common consideration during the pre-start period, so the umpires must very carefully agree how long 'initially' is and when it ends. This could be a topic at the first umpires' meeting.

Typically, when the boats are approaching the starting line to start, the trailing boat will attempt to get an overlap to leeward. If this overlap is established too close to the windward boat, the leeward boat is not giving the windward boat room to keep clear. (Rule 15 and possibly rule 16.) When the boat that establishes the overlap immediately bears away to give the room required, no rule is broken and the umpires should display the green and white flag if there is a protest.

E.7 Fish tail

The fish-tail is a common manoeuvre in the pre-start. A boat clear ahead is 'fish-tailing' when bearing away and thereby creating an overlap to windward on the boat that was clear astern. Rule 15 does not apply, as the new leeward boat has acquired right of way by the other boat's actions. It follows that the leeward boat does not have to initially give the windward boat room to keep clear. The umpires need to observe whether an overlap is established by the boat clear ahead bearing away, by the trailing boat sailing at higher speed, or a combination of both. MR CALL B4 covers this scenario.

E.8 Approaching the Starting Marks

The rules in Section C At Marks and Obstructions do not apply when the boats are approaching the starting marks to start. The umpires must agree when this approach has begun. MR CALL C1 gives a guideline for this.

E.9 Close Tacking

Whenever a boat is tacking close to another, the umpire must call the precise moment his boat passes head to wind (changes tack), and the moment the boat is on a close-hauled course. Any course alteration by the other boat must be called by the other umpire - and whether that alteration is necessary to keep clear.

E.10 Slam Dunk

A 'slam dunk' occurs when two close-hauled boats cross on opposite tacks and the boat ahead tacks quickly as soon as it crosses its opponent. This puts the tacking boat to windward, with or without an overlap.

The umpires need to establish the overlap relationship between the boats at the moment the tacking boat completes the tack, to know whether the leeward boat will be restricted by rule 17, On the Same Tack; Proper Course.

As rule 17 does not apply if the overlap begins while the windward boat is required by rule 13 to keep clear, this manoeuvre puts the tacking boat at a high risk, and it is more common that the boat tacks earlier or leave some distance after crossing before tacking.

When there is a slam-dunk, the umpires also need to watch closely for any changes of course by the leeward boat while the other boat is tacking and immediately afterwards. When a starboard tack boat slam-dunks and an overlap is established before the tack is completed, the port tack boat will not be restricted by rule 15, Acquiring Right of Way, but she will still be restricted by rule 16, Changing Course, if she luffs.

E.11 Dial down

When the delayed penalty system was introduced, the 'dial down' became quite common. A dial down occurs when, in a crossing situation, the starboard tack boat instead of crossing or tacking hunts the boat on port – sometimes even all the way down until both of them gybe. To stop this manoeuvre, MR CALL D6 says that if, on a windward leg, a starboard tack boat bears away to a downwind course that is below her proper course, and as a result the port tack boat has to change course to keep clear, then the starboard tack boat has broken rule 16.1.

Dial downs are still being used, but the starboard tack boat normally only bears away to slightly above a downwind course. The umpires should be particularly prepared for this manoeuvre when the boats are getting close to the windward mark. What the boat on starboard often wants to achieve, is to have the port tack boat tack away. The port tack boat however, would normally try to bear away under the starboard tack boat, and the umpires must make a judgement as to whether or not the starboard tack boat has effectively closed that door for the other boat. **Note** that should the boat on starboard tack bear away to a downwind course at some distance, so that the other boat does not have to change course as a result of the bear away, and then holds her downwind course, this call would not apply.

Should a starboard tack boat with an outstanding penalty make a complete dial down and end up gybing, she will be taking her penalty, because any gybe on a leg to a windward mark is to be judged as a penalty (rule C7.4(a)). The umpires should signal (and remove the flag/shape) the moment the boat gets on a close-hauled course on port tack. The other boat may protest for a breach of rule 16.1 and/or rule 22.2 - but the umpires may not initiate a penalty without a protest.

Should the umpires, after a Y-flag protest, decide that the starboard tack boat broke rule 16.1 and/or rule 22.2 in this manoeuvre, then in addition to the penalty for the breach, an umpire initiated penalty under rule C8.3(b) would be appropriate.

In any dial down situation on the course where the starboard tack boat causes the port tack boat to make a 'full turn' and there is a protest, an umpire initiated penalty under rule C8.3(b) is appropriate (a 'double penalty')

Any dial down is a high-risk move, where any contact between the boats may cause damage. The umpires have to decide whether the starboard tack boat was giving the port tack boat room to keep clear throughout the manoeuvre, and also whether the port tack boat was keeping clear at all times.

E.12 Proper Course

Downwind protests involving proper course are common. It is therefore essential for the umpires to establish the boats' proper courses as soon as possible after they begin their downwind leg. Observing the masthead wind indicator and the angles at which both spinnaker poles and main booms are being set all give a good guide.

When the boats are gybing downwind it is also essential for the umpires to be aware of the angle to the next mark (or finish line), as this may dictate when a boat must gybe to avoid sailing above its proper course.

Proper course falls into the same category as head-to-wind, mark touching and early pre-start entry; accurate judgement can be difficult (and at times impossible) so penalties must be given only when the breach is clear-cut.

Note that there is no restriction that prevents the windward boat from sailing below her proper course (except that she must keep clear of the leeward boat).

E.13 Sailing above Proper Course Downwind

When the boats are sailing close together downwind, the umpires must be aware at all times of the rights to sail above proper course.

These rights can change when, for example, the leeward boat momentarily becomes clear ahead, or gybes. Be aware of a leeward boat performing two quick gybes so as to obtain the right to sail above her proper course. The leeward boat needs to be on a downwind course and get the whole sail across to the other side so that she changes tack – or momentarily actually be sailing ‘by the lee’ on the new tack, before gybing back to the original tack in order to get luffing rights. The gybing boat needs to keep clear of the other boat during this manoeuvre until her main sail is filled again. (Rule C2.4 - 13.2)

Should the windward boat get close to becoming clear ahead, the umpires must expect a quick luff from her to break the overlap. When the windward boat bears away again there will soon be a new overlap, and this time it will have been established from clear astern, and the leeward boat must immediately bear away (or gybe) should she be sailing above her proper course. Note that there is no requirement for the boat that becomes leeward boat to anticipate that an overlap will be established. Should she already be sailing above her proper course the moment the overlap is established, she breaks no rule provided she responds promptly and bears away or gybes onto a proper course. The windward boat does not get any protection from rule 15, and she must keep clear at all times - even when the leeward boat sails above her proper course.

This is a scenario where a penalty may be imposed on both boats (twin penalty), one for sailing above proper course - the other for not keeping clear.

E.14 Overlaps

Careful attention must be given to overlaps as they are difficult to judge from astern, yet they play an important part in the changing obligations both in the pre-start period and on the course.

Particular attention needs to be given to projecting bow rails, stern-hung rudders and the setting of a spinnaker in its normal position. **Note** that flags hanging over the stern do not count for overlaps (or contact). See MR CALL L4.

'Technical' overlap

An overlap is 'technical' if the leeward boat can luff and clear the windward boat. This sometimes happens when an overlap is established close. The windward boat is keeping clear, because the leeward can both luff and bear away without immediately making contact. However, if the windward boat does not start to build distance from the leeward boat, the initial rule 15 ‘protection’ disappears. If, slightly later, the leeward boat advances forward, without changing course, the windward boat may find herself in a position where she is no longer keeping clear.

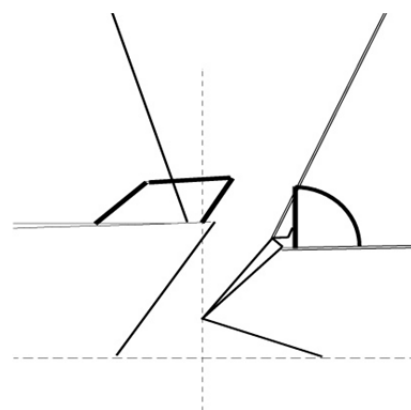

See also MR CALL B17.

E.15 Marks – Room at Marks – Mark-Room

Room given and taken at marks needs to be closely observed. Mark-room may need to include sufficient space to permit a late spinnaker drop, and umpires could be justified in ruling that an inside boat which just manages to pass between the mark and her opponent

without contact (perhaps just good luck) was not given room to sail to the mark when her proper course was to sail close to the mark - or that she had not been given room enough to round the mark as necessary to sail the course.

Note though that, unless rule 18.2(c)(2) applies, mark-room for a boat does not include room to sail her proper course around the mark.

To improve consistency, umpires could discuss the subject prior to each day's racing, as wind and sea state have bearing on what constitutes adequate 'mark-room'.

Mark-room

The definition Mark-Room consists of three parts and it has one limitation:

A boat entitled to mark-room needs to be given room to leave the mark on the required side, and in addition room to sail to the mark if her proper course is to sail close to the mark. She also has the right to room to round the mark as necessary to sail the course.

However, mark-room does not include room to tack unless the boat entitled to mark-room is overlapped inside and to windward of the boat required to give mark-room, and she would be fetching the mark after the tack.

When the boat entitled to mark-room has right of way, rule 18 does not limit her from sailing her proper course (and unless 17 and/or 18.4 applies, even above proper course – a tactical rounding). However, if she does not sail within the mark-room to which she is entitled, she will not be exonerated under rule 21 if she breaks a rule of Part 2, Section A or rules 15 or 16.

See also MR CALL E6.

Rule 18.2(a)

There is no reference to the zone in rule 18.2(a), and that means;

- A boat on port, that tacks to starboard inside the zone, must give room to another boat approaching on starboard that gets an inside overlap from clear astern (provided it is possible to give mark-room from the overlap begins).
- A starboard tack boat has to give mark-room to a boat on port, that ducks her and then tacks to starboard – provided the boats were on opposite tacks when the first entered the zone (see MR CALL E5).
- A boat on starboard that is clear ahead at the zone may slow down, and if the other boat (also on starboard) becomes overlapped on the outside – mark-room will include room to tack around the mark.

Rule 18.2(b) & 18.2(c)

When boats are either overlapped when the first of them enters the zone or clear ahead/clear astern when the boat that is clear ahead enters the zone, the inside boat when they are overlapped or the boat clear ahead is entitled to mark-room, even if an overlap is subsequently broken or established.

This continues to apply until the boat entitled to mark-room no longer needs it, unless the boat entitled to mark-room passes head to wind or leaves the zone. If the boat entitled to mark-room passes head to wind, rule 18.2(b) ceases to apply. Once either passes head-to-

wind the boats will no longer be on the same tack and rule 18 will not apply, however, should the boats again become overlapped during that rounding, rule 18.2(a) may become applicable.

Rules 18.2(d) & 18.2(e)

When there is doubt whether an overlap has been established or broken in time before boats get to the zone, you must assume it has not (rule 18.2(d)).

If a boat has obtained in inside overlap, and the outside boat has not been able to give mark-room from the time the overlap began, the outside boat need not give mark-room (rule C2.6).

Rule 18.3 - C2.7 – Tacking When Approaching a Mark

Note that this rule is changed for Match Racing. If the boat that is fetching the mark has the possibility to luff and avoid establishing an overlap after the other has completed her tack - then the boat that tacked is entitled to mark-room. If she cannot luff and avoid the overlap, she is entitled to mark-room and the boat that tacked must keep clear.

This rule only applies at a mark on the course – not at obstructions or at starting marks.

Rule 18.4 Gybing

This rule only applies when the boats are overlapped. However, if a boat enters the zone clear ahead, and the two boats get overlapped later on - rule 18.4 now becomes applicable if the inside boat (that was clear ahead) continues to be right-of-way boat and must gybe to sail her proper course. (See MR CALL J1) Note that this rule does not apply at a gate mark.

Note also that at a windward mark, a leeward inside boat with luffing right does not have to bear away around the mark, and may use the luffing right before, during and after the rounding. (See MR CALL E4)

Rule 21 - Exoneration

Because the rules in Section C do not override other rules of Part 2, it would have been difficult for an inside keep-clear boat to get to a mark and round it or to get room at an obstruction. Rule 21 therefore provides for exoneration for breaches of rules of Part 2 Section A while a boat is sailing within the room or mark-room to which she is entitled. She would then also be exonerated if she is compelled to touch a mark. However, rule 21 never exonerates any boat for a breach of rule 14.

E.16 Touching a Mark

Umpires must watch for mark touching, as this cannot be protested by another boat. However, this does not always have priority when the boats are close together. If a boat protests, and the umpires have not seen it themselves, the umpires should display the green and white flag as a response. However, if the umpires saw the boat touch the mark, they should then penalise, and if there was a Y flag for the same incident, they may disregard the Y flag from the competitor. See rule C6.5(a).

Before umpires take action under rule C8.2, there should be no doubt at all that the mark has been touched, as movement of the mark caused by a bow wave can make it appear that there has been contact.

Should the boat that touched the mark have gained a controlling position, the umpires may give a red flag penalty.

E.17 Passing Obstructions

Rule 19 applies when boats are at an obstruction. However, if the obstruction is also a mark that boats are required to leave on the same side, and is not a continuing obstruction, then rule 18 applies. Regarding the race committee signal boat, before either boat is approaching it from the pre-start side of the line to start, it does not have a required side (rule 28.2); therefore rule 19 applies up to that time. Once the boats are approaching it to start and until they have passed it, rules 18 and 19 do not apply (Preamble to Section C).

Definition of Obstruction

An object is an obstruction depending on the size of the object in relation to the size of the boats racing. An area, such as an area defined by keep-out buoys, may be an obstruction if the sailing instructions specifically state that it is an 'obstruction'. Umpires and competitors should be clear before racing begins regarding the status of small boats and other objects, and restricted areas, in the racing area.

Rule 19.1

Rule 19 begins to apply when boats are 'at' an obstruction. There is no zone around an obstruction. Boats are at an obstruction when one of them reaches the point where she needs to commit to passing on one side or the other of the obstruction. Once the boats are no longer at the obstruction, rule 19 ceases to apply.

Rules 19.2(a) & 19.2(b)

Rule 19.2(a) is a reminder that the right-of way boat can choose on which side of the obstruction she will pass. But if the boats are overlapped and the right-of way boat chooses to pass on the side that makes her the outside boat, rule 19.2(b) requires her to give the inside keep-clear boat room between herself and the obstruction. If the outside boat is also the keep-clear boat, she must both give room and keep clear. See also rule 21.

The test for whether a boat astern can establish an inside overlap and become entitled to room under rule 19.2(b) is whether the boat ahead is able to give the room from the time the overlap begins. This will generally be fairly obvious when observing the situation.

Note that if the boats are not overlapped while sailing near the obstruction, rule 19 provides no 'protection' to a boat clear ahead that is subject to rules 10 or 13.

E.18 Room at Continuing Obstructions

Should a boat that was clear astern and required to keep clear establish an overlap between a boat that was clear ahead and a continuing obstruction, such as shallow water, rocks, sea wall or a prohibited area, the umpires may be asked to judge if there is room to pass between them at the time the overlap begins (rule 19.2(c)).

Room at continuing obstructions is often related to depth of water for which umpires may have no direct information unless they know the particular shore. Umpires should consider that the boat ahead, for tactical reasons, is probably already sailing as close as she believes possible, in which case, if a keep clear boat astern establishes an overlap, she is not entitled to room and must keep clear. Note that in this case, rules 10 and 11 do not apply and the keep-clear boat that went into the overlap situation remains keep-clear boat while the boats remain overlapped.

A right-of-way boat can always establish an overlap between a keep-clear boat and a continuing obstruction. The keep clear boat must simply keep clear.

Note: rule 19.2(c) does not apply if the boat astern has the right of way. Furthermore, until the moment the overlap is established, rules 10 or 12 will apply between the boats.

A vessel under way, including a boat racing, is never a continuing obstruction (definition Obstruction).

Seven common questions about approaching obstructions can be found at the end of this part of the Manual.

E.19 Illegal Propulsion

Like mark touching, a breach of rule 42 cannot be Y-flagged or red-flagged. Only umpire-initiated penalties can be given, and umpires should have no doubt that a rule has been broken before penalising.

Prohibitions that are single actions (such as ooching) would normally require to be observed more than once before penalising. After the first action the umpires should watch for another action, then carefully discuss and agree whether there has been a breach of the rule, before penalising.

However, a clearly prohibited action should be penalised immediately and without discussion if it results in an obvious advantage. For example when a boat pumps to establish an overlap at a mark or at the finish.

Prohibitions that need to be repeated actions would normally be require being of sufficient duration to draw the attention of both umpires before penalizing.

When a boat is behind and obviously already losing, she should nevertheless be penalised if she breaks rule 42.

A common breach is when a boat roll tacks, and sails for 3-4 boat lengths after the boat is close-hauled before the crew brings the boat upright by moving everybody to windward, and then some of them back down to leeward again. Because a tack (and a roll tack) is completed when the hull is on a close-hauled course, this action is not part of the tack. It would, however, be accepted as part of the roll tack if it happens within a boat length after the boat is close-hauled.

Note that rule 42.2(d) (sculling) is changed for Match Racing (see rule C2.13)

For more information on propulsion, see the ISAF Judges Manual.

When possible breaches are seen but there are some doubts, a general warning could be posted for the next day.

When the event is sailed in smaller boats, the sailing instructions often used to add to rule 42 that the use of the shrouds to facilitate roll tacking or gybing, or to aid the projection of a crew member outboard is prohibited. With rule 86.1 now specifically prohibiting changes to rule 42 in the sailing instructions, this action may now be made illegal and subject to umpire initiated penalties by using the standard wording for it in the ISAF Standard SI's Appendix C 'Handling Boats'.

Class rules may change rule 42, so when class rules apply, the current version of such a Class rule must be discussed at the initial umpire team briefing, unless the SI state that Class rules do not apply.

E.20 Finishing Line Incidents

There are times when a leading or trailing boat has finished, yet a penalty needs to be signalled. The signal should still be given, even if the boat is already dropping her sails. As the boat has not finished until she has taken her penalty and then finished, the Race Committee may need to be advised so that the correct result is recorded.

If the leading boat has an outstanding penalty, or if it appears that one of the boats is likely to take an outstanding penalty close to the finishing line, something which may change the current positions or result in a close finish, the Race Committee should be advised before the boats approach the finishing line.

With the penalty system used in Match Racing, there will be many incidents close to the finishing line, and the umpires need to be prepared for action from a boat with an outstanding penalty. If the boat with the penalty has a reasonable lead, the penalty will often be taken around the finishing mark or almost on the line. If the two boats are close, the boat with the penalty will try to take the penalty while controlling the other boat or to get a penalty on the other boat in order to offset the penalties. This is one of the most challenging situations for the umpires, as rights and obligations may change frequently and the manoeuvres may sometimes be quite surprising. Note that according to rule C2.2, a boat taking a penalty or manoeuvring to take a penalty is not sailing a proper course.

The umpires need to establish, and signal, the moment a boat completes a penalty (rule C5.5). This will happen the moment she gets on a downwind course.

The umpires must also be aware that the boat taking a penalty may re-hoist her spinnaker when she gets to a close-hauled course, before completing the penalty. This complies with rule C7.3(a).

The Call Book gives some guidelines for scenarios where penalties are taken at or close to the finishing line.

E.21 Damage from Contact

Damage caused to a boat cannot be Y-flagged, and penalties for damage cannot be imposed during a match. If the umpires believe there may have been damage, they may request a post-race hearing (through the Chief Umpire) and advise both boats (rule C8.4). The hearing is to establish whether there has been a breach of rule 14.

A boat may protest the other boat in her match, or a boat in another match, under rule 14 by complying with the rule C 6.1(b) (red flag).

Rule C8.6 gives an option of, under certain circumstances, penalising directly for damage.

A policy paper about penalties for damage is included in the ISAF Standard Match Racing Sailing Instructions. Rule C8.6 and this document should be used together.

Notes to umpires about the use of the damage document are included at the end of this Part of the manual.

E.22 Incidents with a Boat in Another Match

As soon as the umpires realise there may be an incident between boats in different matches - they should start communicating as if they were umpiring the boats and they were in the same match. One of the umpires will already be umpiring one of the boats - and the other umpire will take the other. They should umpire as normal. It is very important that this umpiring starts as soon as possible - because it is quite common to lose some of the details in these circumstances.

The umpires should ensure they clearly identify each boat - so there can be no confusion as to who is umpiring which boat. (There may be two Yellow or two Blue boats involved.)

When a Y-flag involves boats in different matches, the two umpire pairs should attempt to discuss the case before making a decision. (This may be over radio.)

The umpires should avoid signalling a penalty to a boat in the other match. If only one of the umpire boats is near by, and the boat in the other match is to be given a penalty, the signalling of the penalty may be delayed until the other umpire boat can get there.

When this is not at all practicable, the umpires may signal a penalty to the boat from the other match, but must make it very clear to everybody which boat is being penalised. (There may be two Yellow or two Blue boats involved.)

The penalty shape/flag should ALWAYS appear only on the correct umpire boat.

If a green and white flag is appropriate, the umpire boat closest to the incident will display the flag.

Note that unlike in Fleet Racing, where a boat that sees an incident between boats may protest, in Match Racing a boat need to have been involved in an incident to protest using a Y-flag.

Note also that rule C2.11 limits the course changes for both boats to that consistent with complying with a rule or trying to win their own match.

E.23 Arm Signals

Appendix C requires arm signals for tacking at obstructions, so umpires should be prepared for them.

To have any meaning these signals must be made by the helmsman, and must be clear. 'Clear' in this sense means clearly seen by the umpires. If a signal from the helmsman is not seen by the umpires, even in the unfortunate situation where the umpires have their view obscured by sails, then the umpires must rule as if the signal has not been given. Umpires cannot 'assume' a signal was given. **Note** that for a boat to use rule 20, she must be close-hauled or above – and must also meet the other requirements in the rule.

A boat that hails for Room to Tack when the requirements are not met breaks rule 20.1. This can be protested by the other boat.

The other boat must still comply with rule 20.2(b), unless the boats are approaching a starting mark surrounded by navigable water to start (Section C Preamble).

E.24 Gaining an Advantage

Sometimes breaking a rule and getting penalised leaves a boat in a better position than it would have been if it had not broken a rule. (Examples are: the outside boat forces the inside boat onto the wrong side of a mark, or a boat luffs illegally and causes the opponent to broach and lose considerable time.) In such cases the umpires have three options: to give another penalty, to give a red flag penalty or to black-flag. The red-flag penalty has specific requirements, see rule C6.5(b).

A penalty should result in a disadvantage to the penalised boat relative to the opponent, and if this is not achieved by one penalty, then rule C8.3(a) requires the umpires to give a further penalty (or more than one further penalty).

It may be that the boat that did not break a rule is so damaged by the boat that broke a rule that no matter how many penalties are given to that boat it will still win the match. In this case, the boat at fault must be black-flagged.

E.25 Deliberately Breaking a Rule

The umpires must penalise a boat when they believe she is deliberately breaking a rule. There is no complete clear-cut answer to how the umpires will decide that a breach of a rule is deliberate, but the Call Book gives some guidelines and examples. This matter could well be discussed at the initial umpires meeting, and any particular point of view should be brought up at the meeting with the competitors. The penalty for a deliberate breach will be a red-flag penalty if the boat has gained a controlling position as a result of the breach and the umpires are not certain that the conditions for an additional umpire initiated penalty have been fulfilled.

E.26 Gaining a Controlling Position - Red-Flag Penalties

A red-flag penalty (rule C5.3) should be used when a boat has gained a controlling position as a result of breaking a rule but the umpires are not certain that the conditions for an additional umpire initiated penalty (either gaining an advantage or the breach was deliberate) have been fulfilled. (C6.5(b))

This may be the case when, for instance, a boat marginally clear astern at the zone barges in between the mark and the other boat and comes out in a controlling position. If it was reasonable for the boat to assume she had an overlap, then she may not deliberately have broken a rule. Although she is in a controlling position, after allowing for a penalty she would probably not have gained an advantage according to rule C8.3(a). A red-flag penalty would bring the boat out of the controlling position, and the other boat would most likely be ahead. Should the boat that broke a rule still be in a controlling position after the penalty, then an umpire initiated penalty for gaining an advantage would be appropriate – this may also be a red-flag penalty.

E.27 Good Sportsmanship

The Call Book discusses 'a breach of good sportsmanship'. Umpires should not hesitate to impose a penalty for unacceptable behaviour, for the betterment of the umpiring system and the sport generally. See MR Call M4. The ISAF Standard Match Racing Sailing Instructions also contain examples.

E.28 Other Umpire-Initiated Penalties

Umpire-initiated penalties for pre-entry positioning, not entering correctly, touching marks, propulsion, gaining an advantage, deliberately breaking a rule and poor sportsmanship have all been discussed above.

Penalties can also be given for not taking a second penalty (or a red-flag penalty) as soon as reasonably possible (rule C8.2).

With regard to the taking of penalties, the Call Book provides guidance on what is 'as soon as reasonably possible'. This is another topic for the initial umpires' meeting so as to help establish a consistent approach.

E.29 Y-Flag Displays

A Y-flag should be displayed immediately after an incident. It is reasonable that a flag shown later than 10 seconds after an incident should be green-and-white-flagged. If there is an incident, it may be reasonable for the umpires to allow a boat to complete any immediate manoeuvre before expecting the boat to Y-flag, as long as they can clearly identify the incident. On a boat with a limited number of crewmembers, umpires may allow a little bit more time.

The rules require the display to be clear, and umpires should interpret this requirement strictly and not respond to a tentative display. A crew seriously believing that a rule may have been broken must leave no doubt that they are seeking a response from the umpires. However, once the flag has been clearly seen by the umpires, they must respond to it, even if the display was brief.

Should a second incident occur before the umpires have signalled the first decision, then the crew must wave the Y-flag again, or if it has been left on display, they must unambiguously draw the attention of the umpires to the second protest.

In these cases the umpires must respond to each protest separately. For example, whistle - blue flag, wait 2 seconds, whistle - green-and-white flag.

Note that there is no requirement for the protesting boat to hail protest.

E.30 Taking Penalties

The umpires need to watch carefully as a boat takes a penalty. A boat taking a penalty shall keep clear of one that is not, so the umpires need to establish when the boat starts and completes the penalty.

When a boat has an outstanding penalty, any tack on a leg to a leeward mark or any gybe on a leg to a windward mark is part of taking or completing a penalty. In each case it needs to be considered if the boat actually completes the penalty correctly.

MR Calls N1, N2, N3, N7, M7 and M11 address this matter.

The umpires must observe that the boat completes the penalty as soon as reasonably possible, and that she does not enter the zone of a rounding mark while taking the penalty. With a tack penalty, the umpires must also observe that the spinnaker head is below the main-boom gooseneck from the time the boat passes head to wind, until she is on a close-hauled course. See E 30 below.

A gybe penalty is completed when the boat is on a close-hauled course, and a tack penalty is completed when the boat is on a downwind course (more than 90 degrees from the true wind).

E.31 Incorrect Penalties

A boat does not get penalised for taking a penalty incorrectly. Instead, the umpires signal with repetitive short sound signals (rule C5.6) that the boat is no longer taking a penalty and that the penalty remains.

This situation occurs when a boat is taking a tack penalty and has the spinnaker head above the main-boom gooseneck when the boat is between head to wind and close-hauled on the new tack, when a boat enters the zone of a rounding mark while taking the penalty or, when a boat has started on a penalty but does not complete it as soon as reasonably possible. Under any of those circumstances, the moment the umpires realise that the boat is not longer taking the penalty correctly, they must promptly signal this to the competitor.

The moment the umpires have 'annulled' the penalty, rights and obligations between the boats go back to 'normal'.

Note that should a boat taking a penalty cross the line and enter the next leg before it completes the penalty (without entering the zone), the penalty will still have been taken correctly.

Should a boat while taking a penalty not keep clear of another boat, she is still taking a penalty. This would be a matter of a Y-flag protest, and the umpires would signal that the penalty is completed, and then, if the other boat protests, signal a new penalty for not keeping clear while taking a penalty. (Rule 22.2)

E.32 Wing Boat Signals

In most cases, umpires should accept wing boat signals or advice as fact. This could include contact between boats, mark touching, zones, overlaps or even confirmation that a skipper's arm signal was made or a Y-flag displayed when the umpires possibly did not see it themselves.

A wing umpire reports only facts and not opinions. He is like an extra pair of eyes for the umpires. However, the umpires may ask the wing umpires for their opinion.

The only time the umpires may refuse to accept wing umpire information as fact is when the umpires are in position to see without doubt that the wing umpire has made an error, or that he is clearly not in a position to give a signal

7 questions about approaching obstructions in the pre-start

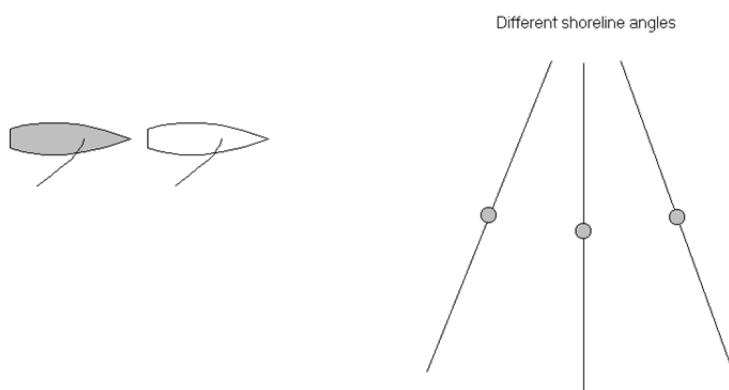

Question 1:

Approaching a shoreline, Blue is clear astern of Yellow. What rules apply?

Answer 1:

- Blue is clear astern and must keep clear while Yellow either luffs or bears away to avoid the shore (rule 12).
- When the boats are at the shore, Blue is not entitled to room because the boats are not overlapped (rule 19).
- When Yellow changes course she must give Blue room to keep clear (rule 16).

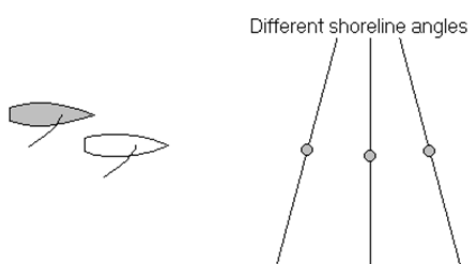

Or

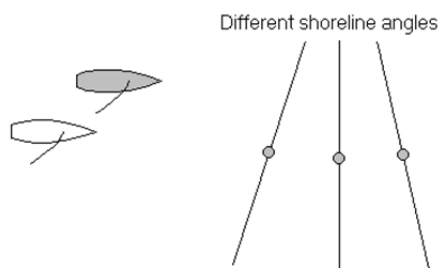

Question 2:

Approaching a shoreline, Blue and Yellow are overlapped. What rules apply?

Answer 2:

- Blue must keep clear while she is overlapped to windward of Yellow (rule 11).
- If Yellow bears away she must give Blue room if required between the shore and herself (rule 19.2(b)).
- If Yellow changes course she must give Blue room to keep clear (rule 16).

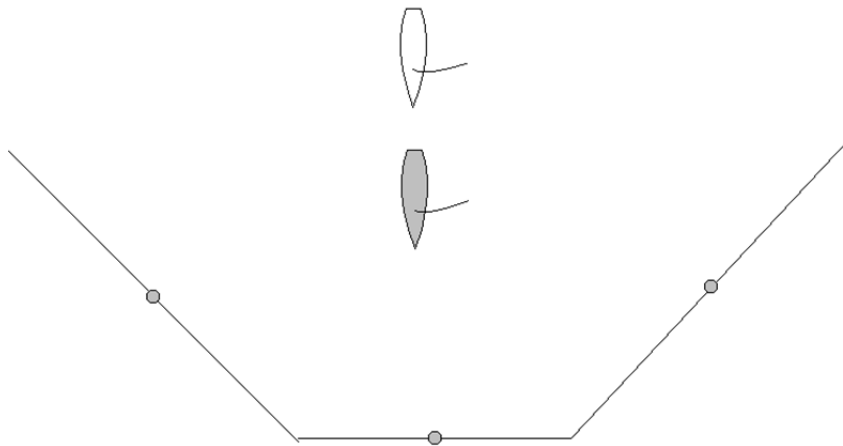

Question 3:

Approaching a shoreline in a wide bay, Yellow is clear astern of Blue. What rules apply?

Answer 3:

- Yellow must keep clear while Blue either luffs or bears away to avoid the shore (rule 12).
- When changing course, Blue must give Yellow room to keep clear (rule 16.1).
- If Yellow becomes overlapped to leeward of Blue, and Blue is between Yellow and the shore, Yellow must give Blue room when the boats are at the shore, even if Blue needs to gybe onto port (rule 19.2(b)).
- If Yellow establishes an overlap between Blue and the shore, Yellow is entitled to room at the shore provided Blue is able to give it from the time the overlap begins (rule 19.2(b)).
- If the obstruction becomes a continuing one and the boats become overlapped, Yellow is entitled to room only if there is room to pass between Blue and the obstruction at the moment the overlap begins (rule 19.2(c)). If Blue was on port and Yellow was on starboard, rule 19.2(c) would not apply and Blue would have to keep clear.

Question 4:

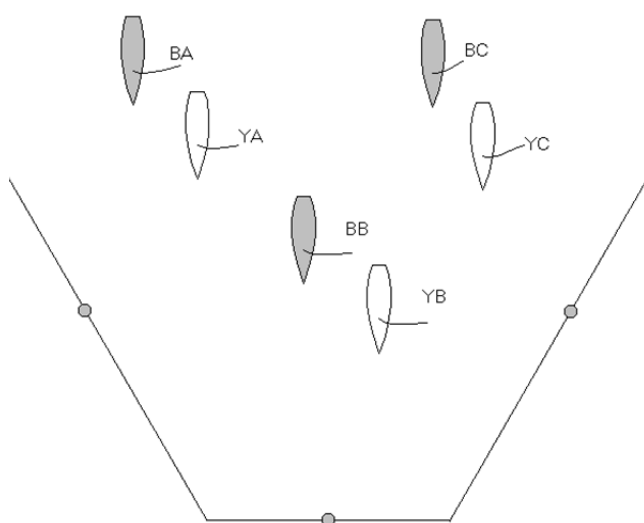

Blue and Yellow are overlapped sailing into a large bay. What are the rules that apply in:

Situation A?

- Rules 11 and 19.2(b) apply. 19.2(c) is not relevant although the shoreline represents a continuing obstruction.
- When at the shore, YA must give BA room to between her and the shore (rule 19.2(b)).

Situation B?

- BB must keep clear of

YB (rule 11).

- If YB changes course, she must give BB room to keep clear (rule 16.1).
- When the boats are at the shore, if the boats are perpendicular to the shoreline, there is no clear inside or outside boat; therefore rule 19.2(b) does not apply and BB must keep clear of YB (rule 11).
- If YB bears away and remains overlapped with BB, she shall give BB room between her and the shore if required (rule 19.2(b)).
- Rule 19.2(c) is not relevant although the shoreline makes it a continuing obstruction.

Situation C?

- BC must keep clear of YC (rule 11) and must also give YC room between BC and the shore (rule 19.2(b)).
- Rule 19.2(c) is not relevant although the shoreline is a continuing obstruction.

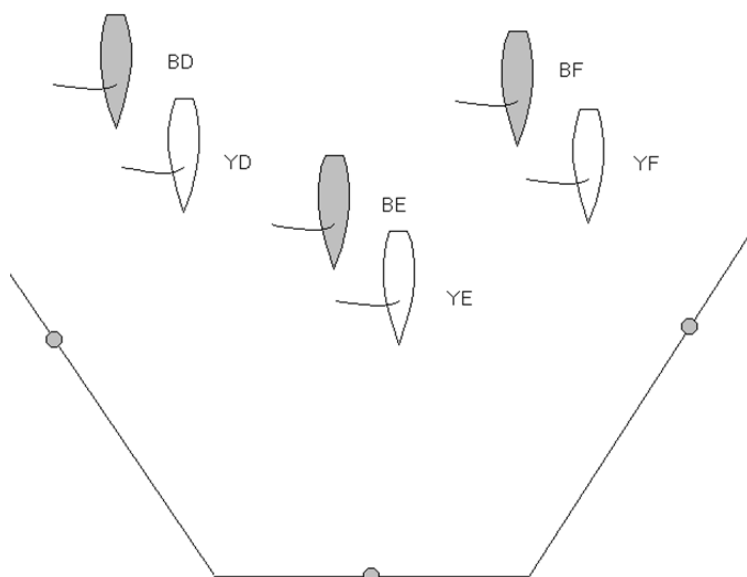

Question 5:

Blue and Yellow are overlapped sailing into a wide bay. What are the rules that apply in:

Situation D?

- YD must keep clear (rule 11) and give BD room between her and the shore (19.2(b)).
- Rule 19.2(c) is not relevant although this is a continuing obstruction.

Situation E?

- YE must keep clear of BE (rule 11).

- If YE luffs at the shore, she must give BE room between her and the shore (rule 19.2(b)).
- If BE bears away at the shore, she must give YE room if required between her and the shore if required.
- Rule 19.2(c) is not relevant although the shoreline makes it a continuing obstruction.
- If YE can bear away and gybe onto starboard without breaking rules 11, 13.2 and 15, then when the boats are at the shore, BE must keep clear and give YE room between her and the shore (rules 10 and 19.2(b)).

Situation F?

- When at the shore, BF must give YF room between her and the shore. Rule 19.2(b) applies.

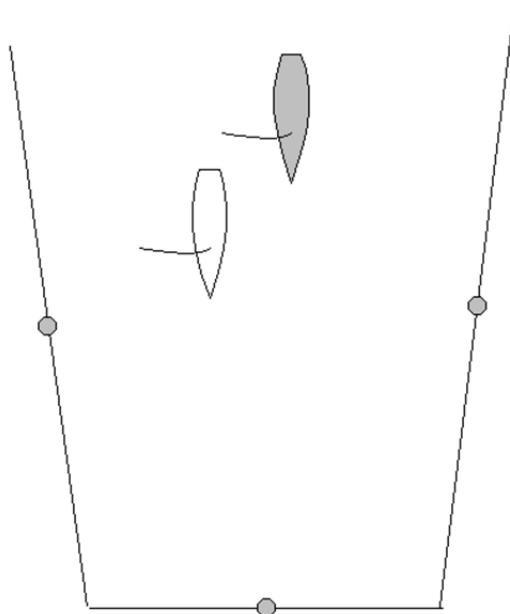

Question 6:

Yellow and Blue are sailing into a narrow bay, where space to manoeuvre will be seriously limited. What rules apply?

Answer 6:

- Depending on the proximity of the boats to the side of the bay, rule 19.2(b) would require Yellow to give room to Blue or Blue to give room to Yellow.
 - If there was insufficient space for either to be able to give room from the time the overlap began, neither is required to give the other room (rule 19.2(b)). Blue is simply required to keep clear (rule 11).
 - If the boats are at one side of the bay, and the outside boat was able to give room at the time the overlap began, she is required to give the other boat room between her and the obstruction (rule 19.2(b)).
- When the boats are at the bottom of the bay, if the boats are perpendicular to the shoreline, there is no clear inside and outside boat; therefore rule 19.2(b) does not apply and Blue must keep clear of Yellow (rule 11).

Question 7:

Blue and Yellow are sailing into a wide bay on opposite tacks. What rules apply?

Answer 7:

- Rules 10 and 16 apply.
- The boats are overlapped because they are sailing more than ninety degrees from the true wind.
- If they are at one of the sides of the bay, the outside boat must give the inside boat room between her and the shore (rule 19.2(b)). If they meet near the bottom of the bay when it is not clear which is the inside and outside boat, rule 19.2(b) does not apply and Blue must keep clear (rule 10).

Notes to Umpires about Damage Procedures:

Explanation of the Damage Procedure

There are a number of things we are trying to achieve with points penalties for damage:

- Minimize damage to keep costs down and to avoid delays while boats are repaired.
- Ensure that penalties fit the breach.
- Ensure there is no advantage to well financed teams
- Avoid delays with hearings. This becomes increasingly important at the later stages when there is a greater number of spectators and sponsors.
- Provide consistent penalties for damage.

Application

- As soon as possible after contact the umpires will inform the race committee by radio giving details of the contact.
- The race committee will log the report and contact the person responsible for the boats.
- The 'boat person' will inspect the boats as soon as possible after finishing and make a report to the umpires. Based on the information available at that time the umpires will decide whether the damage should be classified as level A, B or C.
- When level A is assessed there will be no further action by the umpires.
- When level B or C is assessed a penalty in accordance with the table in the damage guideline sailing instruction will be imposed on any boat judged to have broken RRS 14. The umpires will inform the boat(s).
- When level C is assessed the umpires may also initiate a hearing.

Hearings when point penalties are imposed under this procedure

In order to minimize the number hearings, all point penalty deductions will be imposed by the umpires without a hearing. Should a competitor request a hearing he should be advised that the protest committee may impose a greater penalty. The time limit for a request for a hearing is 'at the time of being informed of the penalty' see RRS C8.6.

Penalties in a Round Robin Series

All penalties are deducted from the skipper's total round robin score. This means that a skipper is penalised for causing level B or C damage even when he loses the relevant match. Half point penalties often only have the effect of breaking scores that would otherwise be tied. And in the same way, if the penalised competitor won the match on the water, he will not lose that point.

Penalties in a Knock Out Series

In a knock-out series half point penalties are not ideal. Having one half point penalty has a similar effect as two half point penalties because the boat only has to win one race to make up for the half point or two half point penalties. Therefore a three quarter point penalty is given for level B damage. A full point penalty is given for level C damage.

All penalties are deducted from the total score for the stage in which the damage happened. If the penalties create the need for additional races and there is time available, such races will be sailed. However, if the additional races will put the program at risk, the stage may be terminated and any ties resolved using the tie break system provided in Appendix C. See rules C10.5 and C11.2.



INTERNATIONAL UMPIRE AND MATCH RACING MANUAL

SECTION F

Umpire Positioning

Contents		Page
F	Umpire Positioning	
F 1	As Boats Enter	F 2
F 2	During the Pre-Start Manoeuvres	F 2
F 3	Pre-Start Same Tack	F 3
F 4	Turning Back	F 3
F 5	Approaching the line to start	F 4
F 6	At the Starting Signal	F 4
F 7	Windward Legs	F 4
F 8	Port and Starboard Crossings	F 5
F 9	Slam Dunk	F 6
F 10	Lee-Bow Tacks	F 7
F 11	Downwind Legs	F 7
F 12	The Forbidden V's	F 9
F 13	Rounding Marks	F 9
F 14	The zone	F 12
F 15	Touching Marks	F 12
F 16	Seven Scenarios for the First Cross	F 13

Second in importance to knowing the rules is good positioning of the umpire boat. Unless umpires are able to see an incident up close and from the proper angle, they may not be able to make the correct call. In some situations, there can be two critical angles, but one will be more important than the other. Good positions are explained below. As umpires gain experience they will develop and fine tune their positioning. Although the basic positioning plan cannot be used at all time, all umpires should normally follow this plan. This would have the effect that the same situation would always be seen from the same angle - and that would lead to more consistent umpiring.

F.1 As Boats Enter



Umpires begin at the port end below the mark. Wing umpires begin at starboard end above the start boat giving room for the boat to pass. Both umpires and wing umpires can observe the correct entry of the boats.

As the boats approach each other, the wing umpire follows close astern of the starboard tack boat and the umpires follow to leeward and abeam or slightly behind the port tack boat.

Seven First Cross scenarios, including the positioning of the umpire boat, can be found at the end of this Part of the Manual.

F.2 During the Pre-Start Manoeuvres

In general, the wing umpires remain to windward of the boats, always ready to take up a position abeam to call overlaps (except when boats are approaching to start, when they should position themselves to leeward).

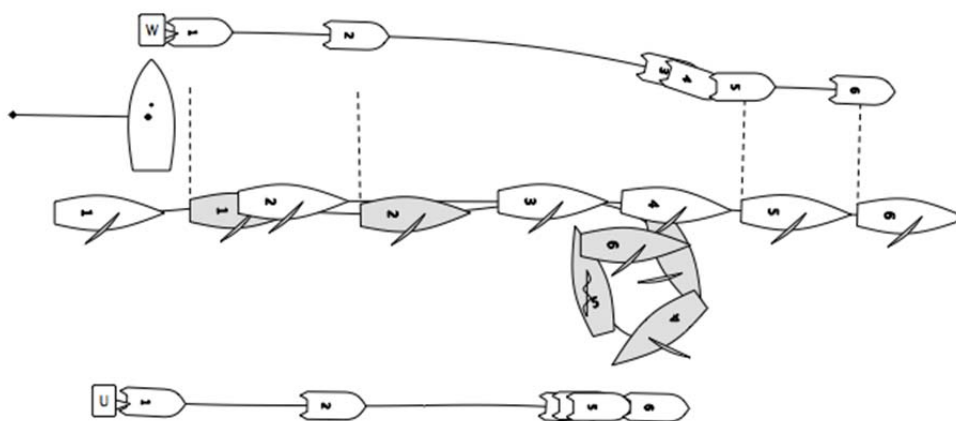

Quite often the boats cannot hold position after a dial up and most of the time the game then moves towards the right. The wing position is to windward, parallel with the stern of the boat clear ahead. From there the wing can see the gap and if asked, eventually help the umpires with information about the gauge during the gybe (positions 4-5).

When requested and when boats are gybing tight, the wing may also call the gybe on the radio to provide a different angle of view.

The Umpire position is to leeward, parallel with the bow of the clear astern boat, ready to stop when the clear ahead boat gybes (positions 4-5) and to start again (after position 6). The general speed of the umpire boat should be similar to the movements of the circling.

F.3 Pre-Start Same Tack

When the boats are on the same tack either sailing nearly parallel to the starting line, or sailing close-hauled or higher, the wing should be abeam and to windward, and the umpires astern or to windward. The umpires should not be abeam and to leeward, as this is the angle being viewed by the wing, and in addition, the umpires will be out of position when the boats change direction. See diagrams.

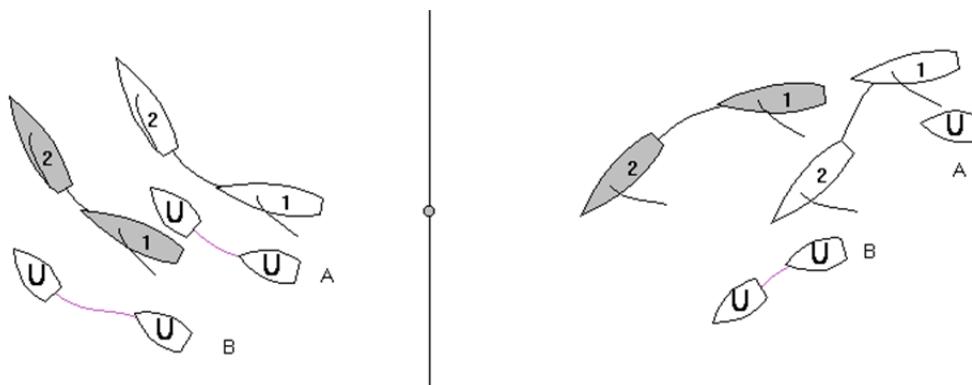

In the first case the boats have luffed from 1 to 2. The umpires abeam (B) will not be in position to see the gap between the boats. The umpires astern (A) have been able to maintain good position.

In the second case, the boats have borne away from 1 to 2. The umpires abeam (B) are now in trouble, putting disturbed water on the bow of a boat, out of position, and needing to escape by turning back and getting further out of position..

F.4 Turning Back

There will be occasions when due to an unexpected manoeuvre by the boats (or doubtful positioning), the umpires need to re-position further to windward. To simply hold back the umpire boat until the boats have passed, and then move into position between them would cause less interference than turning back with the umpire boat. (The reverse may be successfully used to rotate the boat easier.)

When turning back, in most cases the rule is to turn away from the boats, not to turn towards the boats. The diagram below illustrates the situation, and it can be seen how, when turning back, turning away is the best option.

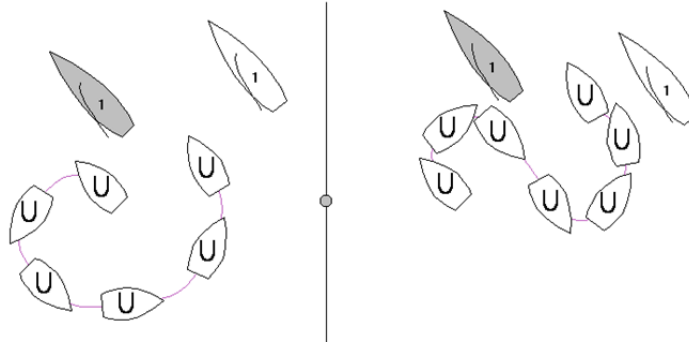

It seems a natural tendency for boat drivers to turn their boat towards the boats, as if the umpires can look only dead ahead. The umpires should be equally effective no matter which direction the boat is headed.

F.5 Approaching the line to start

When the boats are approaching the line to start, the umpires should take position so that they will have a good view if the trailing boat goes for the 'hook up'. The umpires should take position on the windward hip of the trailing boat, and make the calls about the overlap situation from there. They must be careful not to move too far forward, because when the boats head up they will find themselves in a hopeless position. The umpires should keep this position until it is clear that the trailing boat has been 'locked in' to windward, and have no possibility to come back down for the hook again. If correctly positioned, the umpires can then simply slow the umpire boat for a short moment, and they will soon be back in correct position between the two boats.

By positioning to leeward to watch the overlap in this scenario, the umpires will have a hopeless position when the boats become overlapped.

When the boats are approaching the line to start, the wing umpire should position themselves to leeward of the boats.

F.6 At the Starting Signal

At the start, a new rule for the purpose of sailing above proper course comes into effect, as there is now a proper course (rule 17). The umpires need to bear in mind how an overlap that exists at the start was established, in order to know whether the leeward boat has the right to sail above her proper course.

F.7 Windward Legs

In general, the umpires will follow the boat on the left hand side of the course while the wing umpire will follow the boat on the right hand side of the course. When the boats converge the umpires should follow in the wake of the port tack boat whilst the wing is following the starboard tack boat. Whether the port tack boat is then crossing, tacking or bearing away below the stern of the starboard tack boat, the umpires will be in a good position to see any overlap or distance between the boats. When boats cross, the umpires and wing umpire stay on their initial left and right hand side of the course, although they are now following the other boat.

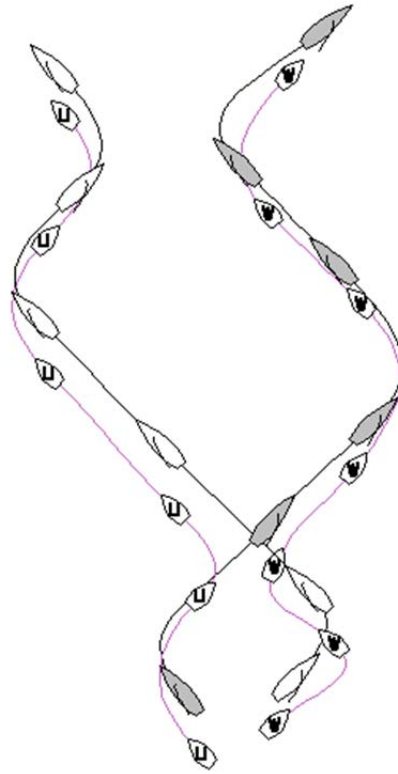

The diagram above illustrates the principle. When the windward mark is to be rounded to port, or when there is a reaching leg, the Chief Umpire may direct the umpires to take the right hand side and the wing umpire the left hand side. Each side has certain advantages and disadvantages, but on balance, 'umpires up the left' is favoured.

With no wing umpire, the umpires should proceed in a position slightly more between the boats - but still 'lean on' the left side, and be prepared to move into position for the most likely scenario whenever the boats approach each other.

F.8 Port and Starboard Crossings

As the boats approach on opposite tacks, the umpires will be astern of the port tack boat, and the wing umpire close astern of the starboard tack boat watching for any course alteration. See below.



With no wing umpire, the umpires should be in the vee between the boats, although closer to the boat on port. A course alteration by the starboard tack boat is more difficult to determine from this position, so the appropriate umpire should watch for movement of the tiller of his boat. See below.



These principles of port and starboard crossings will apply also when the boats are sailing free on the downwind leg, as described in F 11.

F.9 Slam Dunk

The diagram below shows a slam-dunk by the starboard tack boat. By maintaining the left and right hand sides, umpires and wing umpires are in a position to see the gap between the boats, and the overlap situation. The wing boat needs to move into a position where they can observe the overlap situation between the boats, and the umpires will call when the tack is completed. The moment the overlap is established - whether or not the tack is completed, the wing will call the umpires with an open microphone (NOW!), the umpires will be looking for the tack complete.

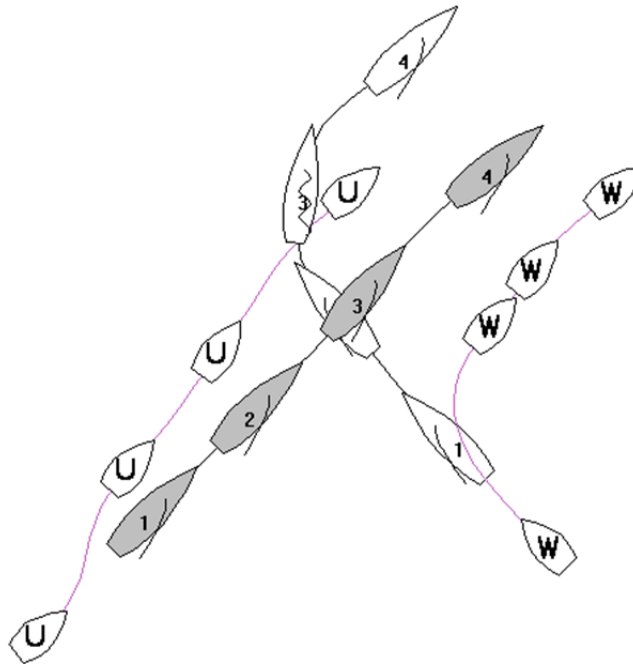

Without a wing umpire, the umpires really need to be in two places at the same time: They need to be abeam of the starboard tack boat as she completes her tack, to be able to see whether the boats at that moment are overlapped. They also need to be in the gap between the boats, to be able to call whether the port tack boat sails above her proper course if the overlap was established from clear astern after the starboard tack boat completed her tack. They also need to observe the relative positions of the boats through the whole scenario, as many rules will apply at the same time during this scenario.

There are no clear-cut answers to the positioning at the slam-dunk, when the port tack boat is dipping the starboard tack boat it is possible there will be a slam dunk.

Note that although rule 16.1 will apply when the new leeward boat luffs, rule 15 will not - if the overlap was established while the other boat was still tacking.

F.10 Lee-Bow Tacks

The diagram below shows the port tack boat lee-bow tacking the starboard tack boat. The positioning will be similar when the port tack boat tacks dead ahead or tacks to windward and ahead. By maintaining the left and right hand side principle, umpires and wing umpires are in position.

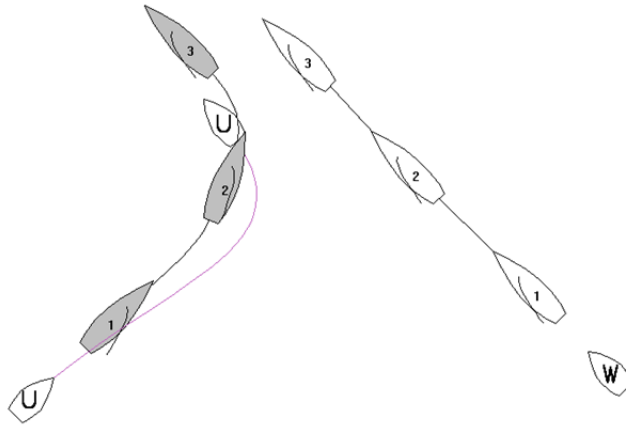

Without a wing boat, the umpires should move into the same final position as above. The relationship of bow and stern will be critical at the time the boat gets back on a close-hauled course, and at the time the non-tacking boat alters course, so at those moments one umpire calls 'Close-hauled' and the other umpire calls 'Altering course'.

F.11 Downwind Legs

In general, the principle of the upwind leg is maintained, the umpires will follow the boat to the left (right hand side of the course when looking upwind) while the wing boat will follow the boat to the right. If the boats cross over then the umpires and wing umpire then change boats, but they do not cross over.

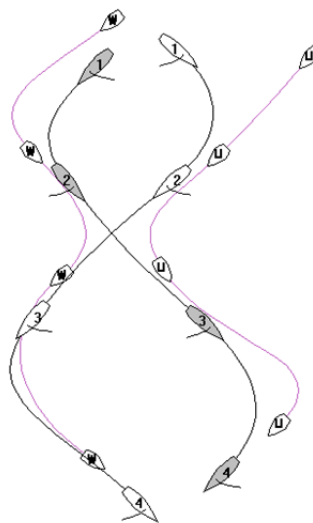

The diagram above illustrates the principle. By keeping astern and slightly to leeward of a boat's line, there should be no disturbance to the boat's wind. The rule of thumb is off the end of the main boom of the boat astern or of the leeward boat down wind.



When the boats are sailing on the same tack, the umpires will take a position astern and the wing umpire abeam, as illustrated in position 1 below.

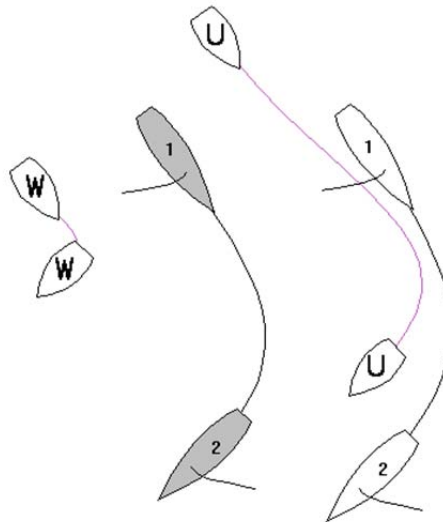

When the boats gybe between position 1 and 2 as shown above, the wing umpire must ensure (1) he is not then to windward of a boat, (2) he is not so far advanced that his boat's wash is affecting a boat, and (3) most importantly, he is not in a position where a boat has turned towards him such that he must escape quickly leaving disturbed water and wash.

If the boats luff on starboard tack, umpires and wing umpires should be able to take up good positions with umpires astern and wing umpires abeam. See below.

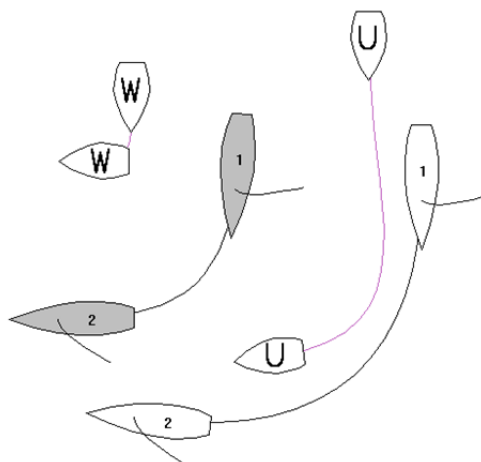

If the boats luff on port tack, the umpires and wing umpires need to react quickly. This is usually best achieved by umpires and wing umpire changing role, with the umpires moving to observe the overlap situation, and the wing umpire observing the gap. The umpires

should then watch for a quick luff from the windward boat. If the windward boat breaks the overlap and then bears away again to re-establish the overlap, the leeward boat may no longer sail above proper course (rule 17). (If this system is to be used, it should be discussed and planned at the initial umpire meeting.) See below.

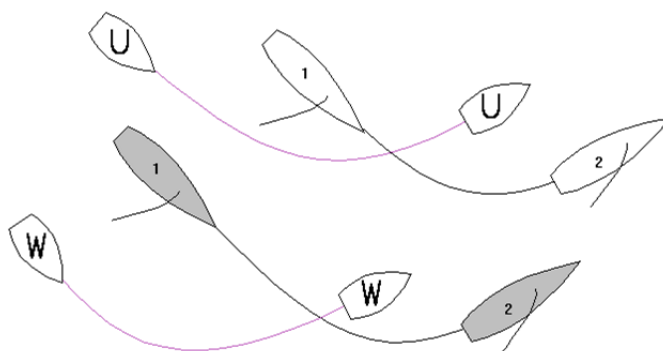

F.12 The 'Forbidden' V's

By the time the boats reach either the windward or leeward mark, both the umpires and the wing umpire should try to avoid, or at least be careful within, the areas some umpires are calling the 'forbidden V's'. These are often no-go areas.

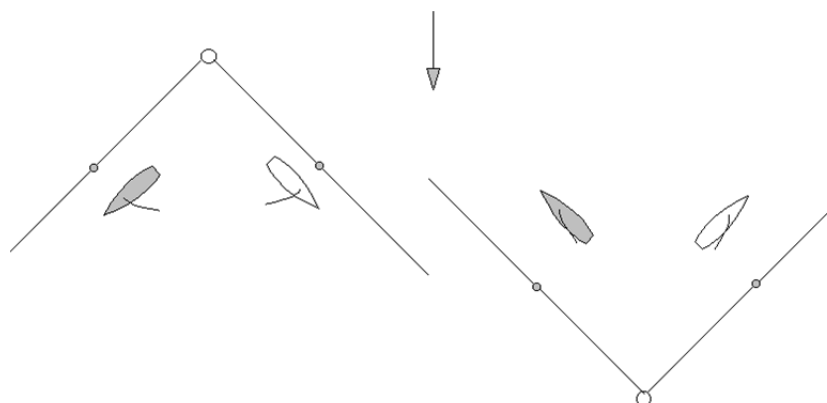

The possibility of the umpires' boat or wing boat forming an obstruction to a boat that has just rounded the mark is obvious, and made worse as at these times the crews are still busy and not yet settled. Disturbed wind is another factor.

The major problem is when the umpires or wing umpires find the need to escape quickly and accelerate away across the bow of one or both boats, leaving disturbed water and wash, usually disadvantaging one boat more than the other.

F.13 Rounding Marks

In general, the umpires will follow from astern and the wing umpire will take a position to call overlap at the zone.

If the boats are well separated, the wing umpire can move ahead carefully with the leading boat to observe the rounding.

The examples below assume starboard roundings. The principles illustrated are consistent with the umpires and wing umpire approaching on their assigned left and right hand side of the course, and being in place to commence the next leg.

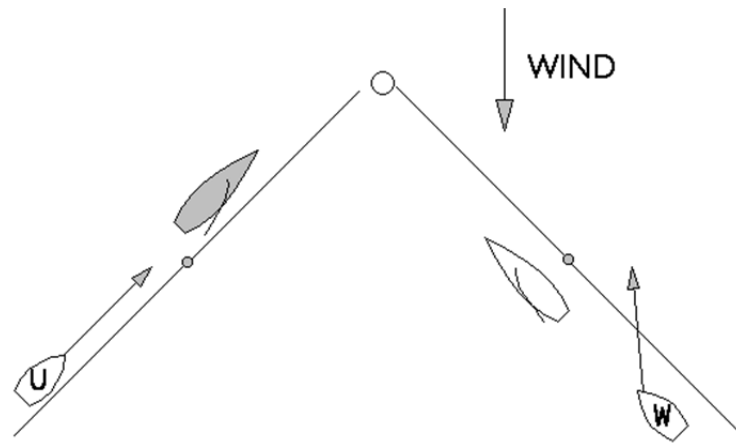
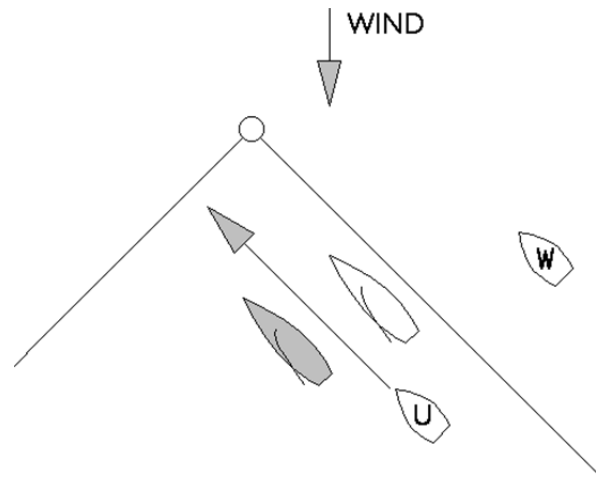
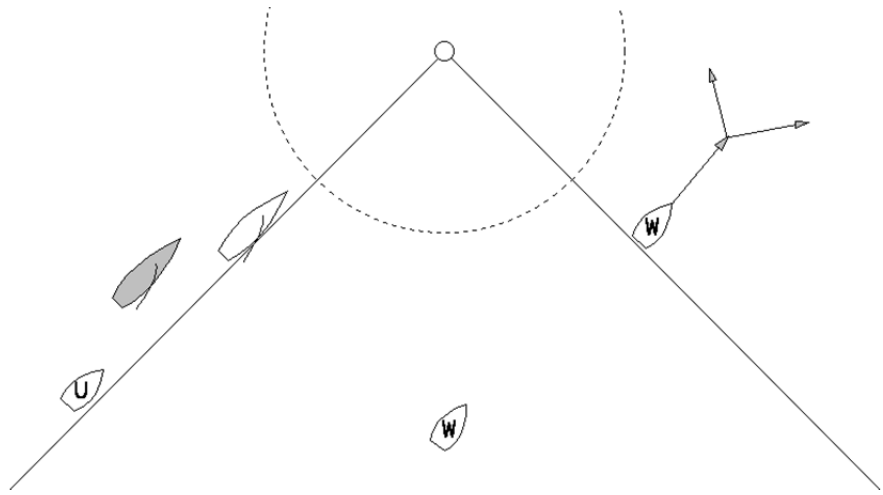

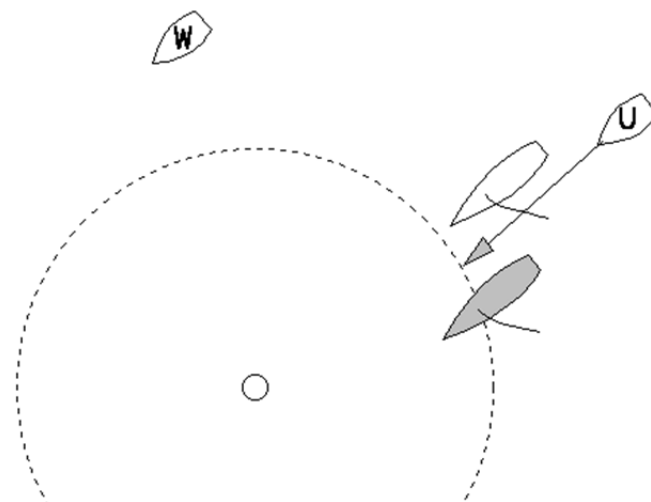
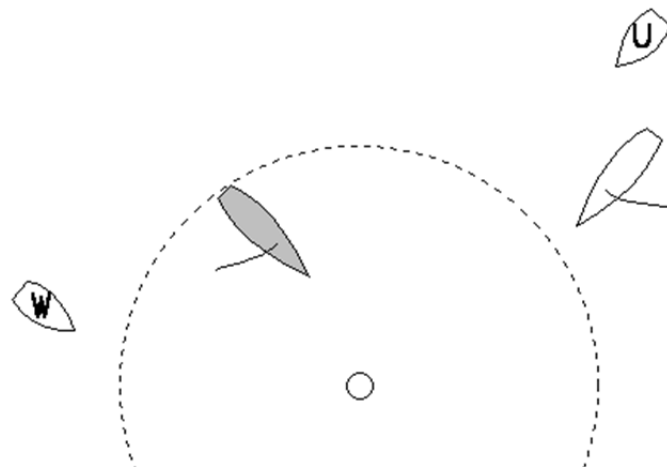
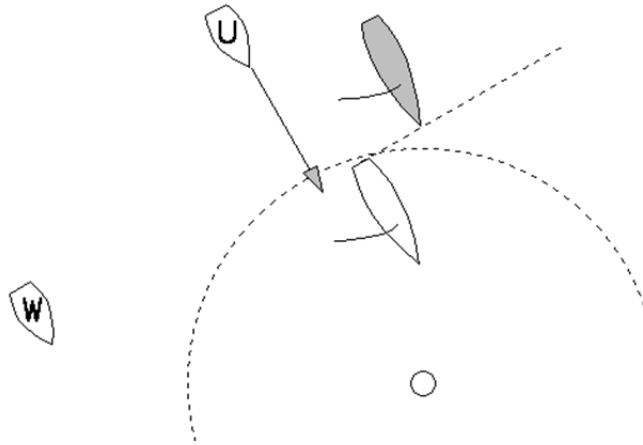

The examples above also show how the umpires and wing umpires are able to keep clear of the 'forbidden V's' without sacrificing good positioning. A fool-proof way for the umpires to achieve this when the boats are close together is simply to follow close astern of the boats as they round the mark.

F.14 The Zone

The diagram below has been included to emphasise the care that needs to be taken by wing umpires (and umpires) in calling 'Zone'.

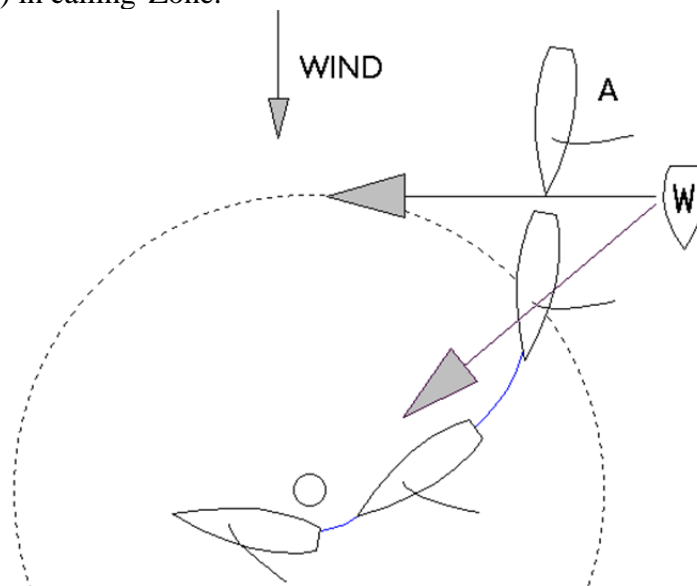

It could appear to this wing umpire that the boat at A has reached the zone. Two lengths will be reached when the wing umpire or umpire is sighting directly towards the mark, and this sight line makes accurate judgement most difficult.

F.15 Touching Marks

When the boats are well separated, umpires or wing umpires can take up position to watch for mark touching.

When boats are rounding close together there are probably more important matters which dictate positioning. If that position also gives a good angle for any possibility of a mark touch, then that is an added bonus, but good positioning to watch for Part 2 matters must take precedence.

To give a penalty for touching a mark, the umpires (or wing umpire) must see the actual contact between the boat (or sail, sheet, crew or other parts) and the mark. The mark spinning is an indication, but not proof that a boat has touched a mark.

The umpires should accept confirmed information from the wing umpires or observers that they have seen a boat touching a mark.

F.16 Seven Scenarios for the First Cross

1. P to windward

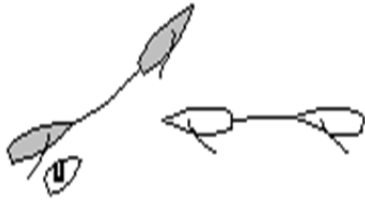

2. P to leeward



3 Both head to wind



4. P tacks onto starboard



5. S gybes



6. Both down

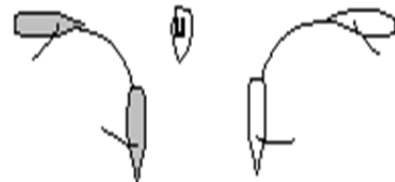

7. P gybes





INTERNATIONAL UMPIRES AND MATCH RACING MANUAL

SECTION G

Wing Umpire and Observers

Contents

Page

G Wing Umpire and Observers

G.1	Wing Calls and Positioning	G 2
G.2	Wing Umpire - Unsighted	G 3
G.3	Wing Umpire – Overlap Calls	G 3
G.4	Wing Umpire – Distance Calls	G 5
G.5	Reduced Number of Wing Umpire	G 7
G.5	Observers	G 9

Being wing umpire is usually one of the duties/functions for the members of the umpiring team. It is no longer common to have a separate wing umpire team.

Some of the advantages of using umpires as wing umpires are;

- They already know the game, and will not need instructions to position themselves;
- If one of the umpire boats break down, there will always be a spare boat and team available. (There should always be a set of umpire flags in the wing boat.)

G.1 Wing Calls and Positioning

Principles

- Consistent positioning and language (actual words used) leads to consistent calls
- However, venues, conditions and boats will cause variations.

In general, the frequency of wing calls should be relative to the proximity of the boats: The closer the boats the more frequent calls, the greater distance between the boats, the less frequent calls.

Before Entry

Outside starboard end of the line

At Entry

- At starboard end, approximately two lengths to windward of the mark, at right angles to the starting line.
- No wing calls unless the starboard boat enters early. Umpire will request confirmation of call before penalizing. Preferred words 'Starboard early entry, starboard early entry'

Immediately after Entry :

- Wing follows starboard boat, closely, for as long as possible. The umpires may request that the wing boat keep transmission open and call –

either	HOLDING	UP (luffing)	DOWN (bearing away)
and either	AIMING	ABOVE (bow of Yellow is pointing above bow of Blue)	BELOW (Bow of Yellow is pointing below bow of Blue)

During the Pre-start:

- To windward and normally two to three boat lengths away, maybe more if it is windy.
- When boats are reaching or higher, in position to see overlaps.
- When boats are sailing very low or circling, stay to windward.
- Last 'minute' before the start, position to call overlaps from leeward.

On the Beat:

- On the right hand side of the course (looking upwind), follow the starboard tack boat.
- Port/starboard crosses - follow directly behind starboard.
- Slam dunk - cover tack on to port tack - position to judge overlap. Signal overlaps irrespective of whether boats are on opposite tacks.
- Cover tack to starboard and while both are on starboard - astern of both boats.

- If boats really separate (more than six boat lengths) - go with the boat ahead to watch mark rounding.

Downwind:

- On right hand side (looking downwind).
- Position to call overlaps - but always clear of potential gybe and rapid, immediate luff.

At Marks:

- When on same tack or towards leeward mark, in position to call overlaps at zone (two lengths), keeping clear of boats exiting from rounding.
- When on opposite tacks to a windward mark, follow starboard tack boat and positioned to see mark touches. Be aware of the umpire boat position, which will often be to follow the boats around the mark.

When Boats are on Different Legs:

- Follow right of way boat - normally starboard tack boat into windward mark.

Other Possible Wing Boat Calls:

CLEAR (arm horizontal)	Boats are clear ahead / clear astern
OVERLAP (arm vertical)	Boats are overlapped
SIGNAL - BLUE / YELLOW	Arm signals seen from one of the boats
CONTACT (hand touching head - repeat)	Contact with mark or boat
YANKEE BLUE / YELLOW	Y-flag seen on Blue or Yellow
NEGATIVE	Answer 'No' to a question from the umpires - for example 'Did you see contact?'
AFFIRMATIVE	Answer 'Yes' to a question from the umpires
YELLOW / BLUE	Following one of the boats, normally starboard tack boat on a beat
HOLDING	
UP (luffing)	
DOWN (bearing away)	
PROPER COURSE or ABOVE/BELOW PROPER COURSE	When boats are on different legs of the course
LAYLINE : BOAT LENGTHS	Approaching windward mark following starboard tack boat
ABOVE/BELOW LAYLINE	
BLACK - OUT	The wing is in no position to give a call

Correct positioning is the most important skill required of the wing umpire. A good wing umpire must not only have the skills to place his boat in the best position to sight overlap between the boats, but he must also be aware of the position of the umpire boat so that he can place his own boat in the best position to assist the umpires. For example, if he saw the umpires take up a position abeam of the boats to observe overlap or distance from a mark, then a wing umpire should move into a position astern of the boats to observe the gap between the boats and any course alterations. A good wing umpire would make such a move without the need to be directed by the umpires.

Positioning applicable to the wing umpire is also included under 'Umpire Positioning' (Part F of this Manual).

G.2 Wing Umpire - Unsighted

It is not uncommon for the wing umpire to be making calls when a course alteration by the boats prevents the wing umpire making further accurate calls until he gets repositioned.

The moment the wing umpire cannot call accurately, the umpires must be informed. If the last call had been 'Overlap', but then the wing umpire stops calling because he cannot get an accurate sight, the umpires may mistakenly believe there has been no change to the overlap position.

A simple and unmistakable word of advice is required so the umpires immediately know that the situation may have changed since the most recent call, and also know to expect no more calls until the wing umpire can again get an accurate sight.

The preferred call is '**Blackout**' and this call should be used.

G.3 Wing Umpire – Overlap Calls

The following diagrams illustrate the correct radio calls from the wing umpire.

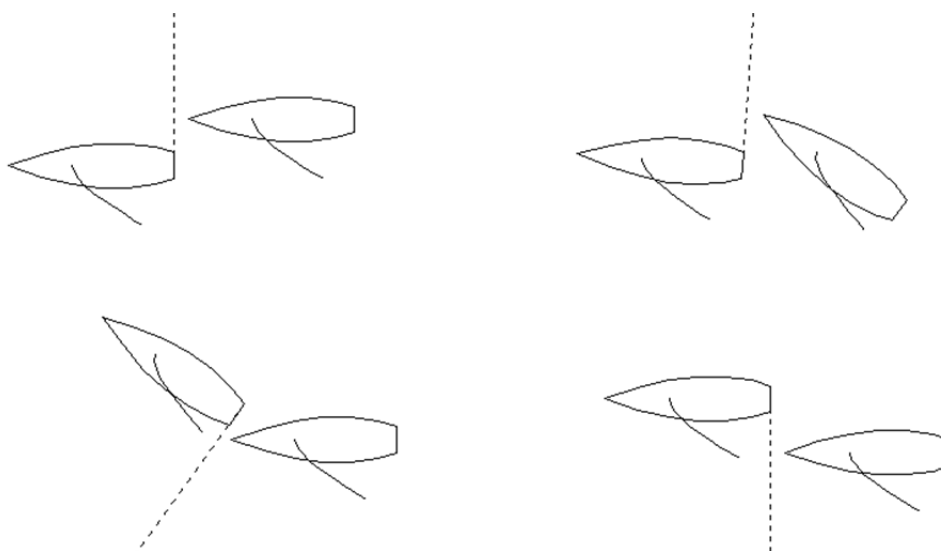

In all the above examples the leading boat is clear ahead. The wing umpire call is 'CLEAR'.

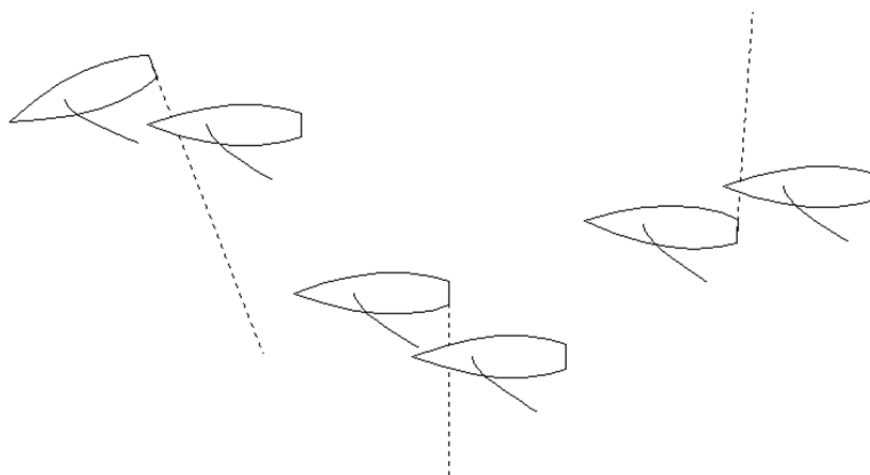

In all the examples at the bottom of the previous page, the boats are overlapped.

The Chief Umpire may instruct the wing to call 'Seventeen' when the overlap is established from clear astern within two lengths of the windward boat.

Unless other ways instructed: During the pre-start and until the starting signal, the wing call is 'OVERLAP'. After the starting signal there may be a proper course restriction on the leeward boat, depending on how that overlap was established. Even if the overlap was established from clear astern by the leeward boat the call from the wing would still be 'Overlap'. It is of great importance that umpires bear this in mind the last minutes before the starting signal.

G.4 Wing Umpire – Distance Calls

Wing umpires are frequently in a position where they can provide valuable information to the umpires on distances.

(a) Abeam during the Pre-Start

In all situations when astern of a boat, it is difficult for the umpires to estimate a distance ahead of the boat's bow. The wing umpire can assist the umpires by commencing his 'clear' calls early and including distance information with the call. If the boat astern is sailing faster, the calls could be:

'Clear one length'

'Clear half length'

'Clear two metres'

'Clear one metre'

'Overlap'.

This enables the umpires to assess the closing speed and distance, and plan and position accordingly.

If the boat ahead is sailing faster, the calls will be similar to those above but in reverse order, and this will also assist the umpires.

(b) Abeam Downwind

Downwind, if the umpires are astern they need to know if the boat astern is gaining on the boat ahead and at what rate, and they need to know the distance.

The calls can be similar to those made from abeam during the pre-start, except the calls must commence when the boats are two to three lengths apart, and be repeated whenever there is a change in distance.

(c) Astern

This is a distance call given in response to a radio request from the umpires. In a situation where the umpires become positioned abeam, and the wing umpire astern, the umpires may ask 'Wing Three, distance apart please'.

Wing Umpire Three may respond 'Half a length'.

(d) Apart and on Opposite Tacks

This is a distance call given in response to a radio request from the umpires. When boats on opposite tacks (either upwind or downwind) are on converging courses, the umpires may seek to know whether the boats are on collision courses, or if not, which boat is ahead and by how far.

The diagram below shows (not to scale) a possible situation where the umpires may ask 'Wing Three, give a distance call please'.

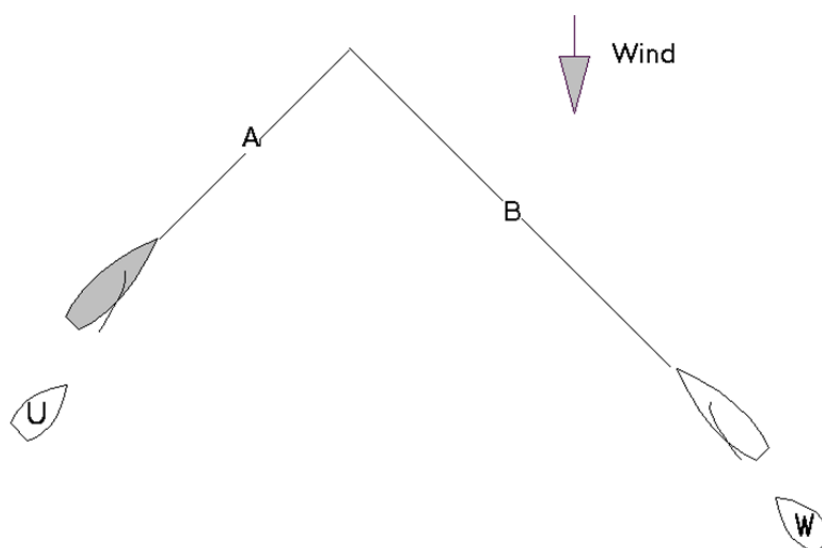

The wing umpire makes an estimate of distance A and responds 'Four lengths NOW'. The umpires can see distance B at the call 'NOW'. If they estimate B to be six lengths then they know the port tack boat will cross ahead. If B appears to be four lengths then they can prepare themselves accordingly.

(e) Crossing Situations

This is a call given in response to a radio request from the umpires. When boats on opposite tacks (either upwind or downwind) are approaching a close crossing situation, the umpires need to know just how close that is.

The diagram below shows a possible situation where the umpires may ask 'Wing Three, call bow-to-bow please'.

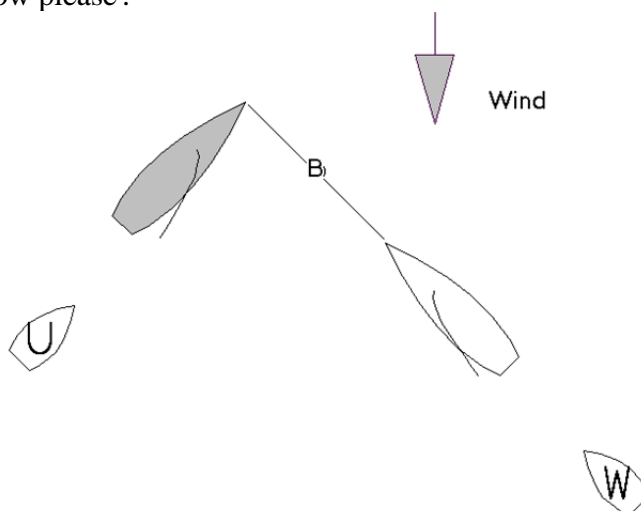

When the bow of the leading boat first meets the extension of the other boat's line, the wing umpire responds 'BOW-TO-BOW.....NOW'. The umpires can see distance B at the call. If B is greater than one length then the crossing appears safe. If B is less than one length then there may be a problem.

It is a good practice for the umpires to call back to the wing umpires with information about the distance. This keeps all involved in the game.

G.5 Reduced Numbers of Wing Umpire

One wing umpire per match is an ideal that is often not achieved. One or two wing umpires are common, and systems have been created to utilise those wing umpires to their maximum.

(a) No Wing Umpires

This is unsatisfactory. It is possible to have a wing umpire in place for all but one of the pre-start periods by using the 'rolling system'. This requires Umpire 2 to serve as wing umpire for Umpire 1, Umpire 3 to serve as wing umpire for Umpire 2 etc. Only the last umpire pair will be without a pre-start wing umpire. (Alternatively, the last umpire pair could be wing umpire for all other pre-starts.)

(b) One Wing Umpire

The wing umpire attends to all the pre-starts and then takes up position on the leeward mark. As a match rounds the leeward mark, the wing umpire stays with that match until he meets the next match coming down the downwind leg. He turns and follows that match down and around the leeward mark and back up the windward leg until he meets the next match coming down etc.

All the pre-starts and nearly all leeward mark roundings and finishes will have a wing umpire.

(c) Two Wing Umpires

The first wing umpire attends to Match 1 pre-start then stays with that match to the windward mark and takes up position by following a match down the downwind leg until he meets the next match coming up. He turns and follows that match up and around the windward mark and back down the downwind leg until he meets the next match coming up etc.

The second wing umpire attends to all other pre-starts and takes up position on the leeward mark as described in (b) above.

All the pre-starts, all windward mark roundings and nearly all leeward mark roundings and finishes will have a wing umpire. Two wing umpires can therefore cover nearly all the racing.

(d) Umpire Assistance

Even greater coverage of all racing is possible when there is a reduced number of wing umpires, by utilising umpires as their matches finish. Immediately, when Matches 1 and 2 finish, their umpires return to the course area and serve as wing umpires for any other matches requiring assistance. If using radios, as Umpire 1 and Umpire 2 finish they transmit 'Umpire 1 (or 2) is free. Does any umpire require a wing umpire?'

Umpires should assist each other whenever possible. For example, Match 2 and Match 5 are rounding a mark about the same time. Match 2 is very close, Match 5 has wide separation, and there is no wing umpire nearby. Umpire 5 may be able to

serve temporarily as wing umpire while Match 2 rounds the mark, then resume duties on his own match.

As long as any of the matches in a flight are in progress, available umpires should keep a look out for situations where they could be of assistance.

G.6 Observers

Match Racing Observer Brief

Prime Role

To signal to the match umpires: Overlaps

- Contact - with other boats and marks

Additional Role

- Possible witness for protest hearings
- Stay with boats after each session to assist with damage control system

Arm Signals

Overlap	Arm vertical
Clear ahead/Astern	Arm horizontal
Contact with boat or mark	Touch top of head and lift off, repeat
No contact - in close situations/mark roundings	Thumb up
Distance between boats at closest point	Use both hands to show the distance
Un sighted	Arm down
Umpire wants a signal	Umpire arm up and down

Hints and tips

Overlaps	Look out at right angles to aft most part of boat, including rudder, etc. Watch for spinnakers creating the overlap Signal overlap when boats are on opposite tacks (especially when cover tacking) Observers, cameramen and flags do not count for overlaps Keep signalling while boats are within half a length ahead or two/three lengths to leeward/windward. Observer on trailing boat repeat signal from observer on leading boat Checking observer overlap calls. Before racing use an umpire boat to come from astern and get the observer to signal an overlap as the umpire comes in line with the transom. Feedback the accuracy to the observer.
General Items	Observer pairs will be weight equalised. Know your pair, know your weight and wear similar weight clothes Stand on the stern, do not sit while racing Pairs should harmonise positioning - weight to windward e.g. Do not hang on using the backstay or any other control system Try not to obstruct any cameramen on the boat Do not discuss racing issues with the crew after the warning signal. Using the phrase "I am not allowed to help you while racing" may be useful. Before that, try to be helpful if they ask
Umpire Action	Observers need to be aware that if they signal a mark touch, the umpires will penalize the boat Umpires (and competitors) will rely on the observers signals for overlaps - so they must be accurate.
Safety	Wear a proper personal floatation device Be aware of the other boat - do not stay in a dangerous place
Declare any conflict of interest	



INTERNATIONAL UMPIRES' AND MATCH RACING MANUAL

SECTION H

Race Management

Contents		Page
H	Race Management	Page
H.1	Introduction	H 2
H.2	Required Personnel	H 3
H.3	Course	H 4
H.4	Starting Lines	H 8
H.5	Starting Procedures	H 9
H.6	Course Changes	H 11
H.7	Finishing	H 12
H.8	Scoring	H 12
H.9	Race Committee and Umpires Equipment	H 13
	Sample Starting Sequence	H 14
	Sample Score Sheet	H 15
	Sample Damage Report Form	H 16

H.1 Introduction

Notice of Race and Sailing Instructions

The Notice of Race should be published as far in advance as possible. Both the Notice of Race and the Sailing Instructions should be reviewed with the Chief Umpire in advance of publication.

ISAF Standard Notice of Race and Sailing Instructions for Match Racing are at all times posted on the ISAF website. The standard must be used as the basis for the Notice of Race and the Sailing Instructions for a graded event. For all other events, ISAF recommends that event organisers follow the standard as much as possible.

Event Format

A Match Racing event can have many different formats.

- Will supplied boats be used?
- Will advancement be based upon a ladder system or on one or more round robins? How will entries be determined?
- Will there be a qualification round for un-seeded competitors?
- How will the results be determined if there is insufficient time to complete the schedule?
- What will the damage deposit be?

Each of these options should be decided early on and mentioned in the Notice of Race.

A discussion of the merits of various event formats can be found in Part M of this Manual, together with sample pairing lists and criteria for using them.

Relationship with Competitors and Umpires

Before the event, the Chief Umpire (or the umpires) and the Principal Race Officer (or the Race Committee) should meet and cover the matters described in the briefing check list at the end of Part D of this manual. The Principal Race Officer and the Chief Umpire should then conduct a competitors briefing to cover the same subjects. The Principal Race Officer should refer to the Chief Umpire if any questions arise at this meeting regarding the Sailing Instructions or other conditions governing racing.

The Principal Race Officer and the Chief Umpire must work very closely together. They should meet before and after racing each day to discuss and resolve matters such as course location, spectator control, the condition of boats, visibility of signals and anything else affecting the quality of racing.

Daily meetings between competitors and umpires, both before and after racing, are essential for the development of the sport and should be encouraged. The Principal Race Officer should conduct a morning pre-race briefing to discuss Race Committee procedures, announce the sailing area to be used and other related matters. The Chief Umpire will conduct an afternoon de-brief, at which the umpires will review any calls the competitors wish to discuss. It is helpful for the Principal Race Officer to attend this meeting and be prepared to respond to comments and questions regarding Race Committee procedures.

Borrowed Sailboats

The greatest challenges to the organiser of a match race event are associated with borrowed sailboats. The owners of those boats will be rightfully concerned about how their boats are used and their condition at the conclusion of the event. The event organisers must impress upon competitors and umpires that the event could not be conducted without the generosity of the owners and that the owners' boats must be respected. Several steps may be employed which will ensure the owners' continued support of the event. Before the event, the event organiser ought to establish guidelines for the use and care of the boats. A sample set of conditions is an attachment to the ISAF Standard Sailing Instructions. The owners should be permitted to comment on those guidelines and to add requirements that may be unique to the class of boats to be sailed. Just before the event, one member of the Race Committee should survey each boat with its owner, or a representative, present. All equipment should be inventoried and any damage noted.

From the very first competitor's meeting, umpires and the Race Committee must impress upon the competitors that proper care of the borrowed boats is essential. Inspections should be made at the conclusion of each race day. It is advisable to take photographs of any damage for later use in making an insurance claim or determining responsibility for the damage. Advise the competitors that a withdrawal will be taken from their damage deposit if the boat is not secured properly. ISAF encourages event organisers to advise the competitors that they may be excluded from the remainder of the event, and not permitted to participate in future events conducted by the same organising authority if a team handles a boat improperly or causes damage which may have been prevented with proper seamanship. A sample damage report form is attached at the end of this Part of the Manual.

Another important aspect of conducting a match racing event is the equalisation of borrowed boats. An event organiser is well advised to arrange for one or more people to equalise the tuning of each boat and make sure all equipment is working properly. Issues to consider are:

- Condition of the underwater hull
- Location of the mast
- Forestay length
- Shroud tension
- Condition of sails
- Electronics
- Mast head flies
- Compasses
- Deck layout
- Weight of boat, and distribution of weight on boat
- Excess gear removed

It is far more important to select boats that are as equal as possible than it is to select the fastest boats in a fleet. If the boats cannot be equalised, match pairs of boats that are as equal as possible and keep them together throughout the round robin. This will increase the complexity of the boat rotations, but will provide for fairer competition.

During the event, the Race Committee should keep track of the performance of each boat (in addition to team finishes), before the semi-final series begins. The Race Committee will then be in a position to select the four boats with the most equal records.

H.2 Required Personnel

Umpires

The umpires must be prepared to respond to situations in every match, so an organiser must arrange for a sufficient number of umpires. At a minimum, that means two umpires for each match in progress. Therefore, if the field consists of ten teams, with five matches in progress at a time, the event organiser will need to arrange for at least ten umpires. For most events, pairing one experienced with one less experienced umpire is acceptable.

As the level of competition and importance of events increase, so do the requirements for the number and skills of the umpires. For regional events, it is highly desirable to have at least one ISAF International Umpire and to provide two additional umpires who will serve as wing umpires (see Part G). For graded events, the minimum requirements for umpires have been established by ISAF in the ISAF Standard Guidelines for Grade 1 and Grade 2 Match Racing Events.

Race Committee

Race Committee personnel should be experienced and capable of spending many hours on the water without degradation in their performance.

Duty of the Race Committee boat is especially hectic and adequate staffing is very important. The minimum recommended complement is:

- Sound signaller
- Flags (at least two people)
- Line sighter
- Timer
- Recorder
- Principal Race Officer

Each mark boat should be staffed whenever possible with at least two people.

Other on-the-water personnel

If crews change boats between flights, provision must be made for changes. Several boats, preferably soft-sided, should be assigned this duty, and nothing else. If possible, have extra people aboard each change boat. They will board each sailboat and sail it under mainsail alone while the competitors are taken to their next boat. The umpires may also assist with the change of crew.

The most frequent and frustrating cause for delay between flights is the time lost due to breakdowns. No matter how much effort is expended in inspecting and repairing the boats ashore, breakdowns are inevitable. Event organisers are well advised to assign at least one boat, with sufficient, skilled personnel, the exclusive task of repairing boats on the water. The repair boat(s) should be fast and easily manoeuvrable and, if possible, soft-sided. Spares of any items likely to break (such as spinnaker poles, sails, tillers and tiller extensions, sheets, winches and shackles) should be put aboard as well as tools and sail repair tape.

Depending upon the nature of the event, an organiser may also need to arrange for personnel to staff spectator control, VIP, press, television and photo boats..

H.3 Course

Location

Match racing has a great deal of spectator appeal. For that reason, it is becoming increasingly common for match races to be conducted in locations that would be unsuitable for fleet racing. Competitors, particularly those at the highest level, understand and accept the fact that racing is likely to be conducted in locations in which conditions may not be the same across the racing area.

An organiser may well want to conduct a match racing event in a harbour, near shore or in some other location conducive to spectating. If so, the organiser should take care to advise the competitors and umpires of local conditions such as shoals and shipping channels. On the other hand, it is best to avoid conducting racing in areas in which a great deal of recreational or commercial boat traffic is expected.

Configuration

The preferred match racing course is a windward-leeward course with a downwind finish. Roundings are usually to starboard because this presents the most tactical challenges and opportunities for lead changes.

Options are one or more laps. Whenever possible, two laps should be used. This will provide the competitors with the most tactical challenges and opportunities for lead changes. One-lap courses may be appropriate when the time needed to complete a round robin is severely constrained or when unfavourable weather conditions are expected. Three lap courses may be appropriate if the sailing area is limited in size.

Given the short course length and the desire to provide opportunities for lead changes, it is critical to set the course properly. This means providing downwind legs that are as square as possible to the wind in which the boats are sailing. For a discussion on the effect of current, see below.

The leeward mark should be approximately 50 meters to windward of the starting line. If possible, the starting buoy should be of a different shape and/or colour than the leeward mark. A course diagram is shown in the ISAF Standard Match Racing Sailing Instructions on the ISAF web site.

Current

Race Committees must be alert to the fact that the wind observed from an anchored race committee boat will not be the same as that observed from a boat drifting or sailing in current. In areas in which current is a factor, Race Committees should rely upon wind readings from drifting Race Committee boats.

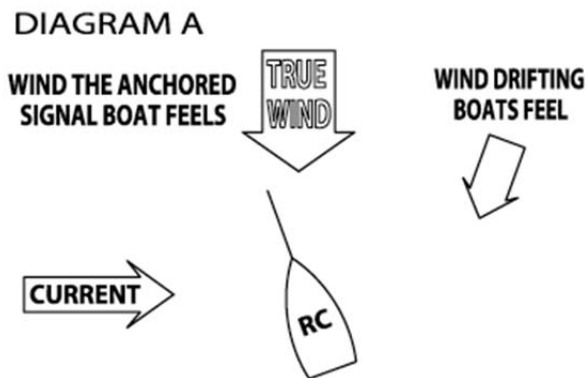

If the current effect is marginal, the Race Committee should consider sacrificing the windward leg slightly in order to provide a square downwind leg. In this case, the windward mark may be placed slightly up current. The result will be that the boats will sail upwind on one tack for a longer time than the other tack. As races progress, the Race Committee should time the boats on each tack as they proceed downwind. Ideally, they will sail an equal time on each tack. If not, the windward mark can be adjusted between flights or a course change may be undertaken (see below). If the boats sail downwind longer on starboard tack, the windward mark should be moved to the left looking upwind, and to the right looking upwind if they sail longer downwind on port tack.

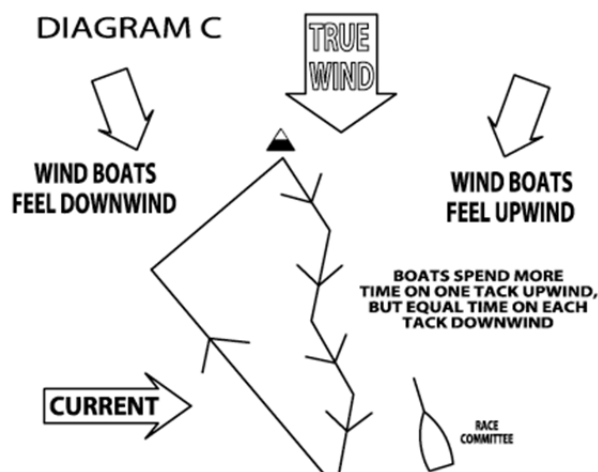

If the effect of current is significant (i.e. a strong current running almost perpendicular to a light to moderate wind), the use of two windward marks should be considered. The Standard Sailing Instructions in Part L includes a section to be included in the sailing instructions. If the current is running from left to right looking upwind, the boats should be instructed to pass mark WS first and then WP. In a right to left running current looking upwind, the boats should first pass WP and then WS. Marks WS and WP should be set up to provide square upwind and downwind legs. The compass bearing to these two marks from the leeward mark may vary by more than 40 degrees depending upon the speed of the wind and current, the difference in the bearing between the wind and the current and the length of the windward leg. (Note that in each case, the leeward mark should still be passed to starboard).

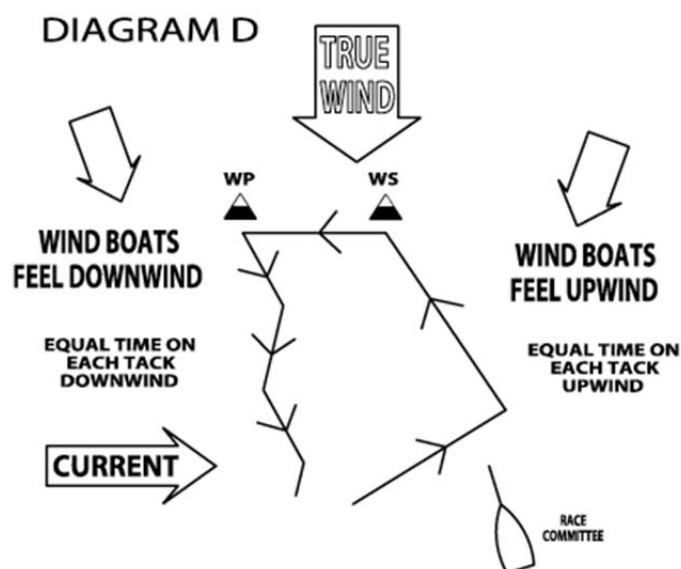

Length

The attraction of match racing, for spectators and competitors alike, is many short, tactical races. Thus, races should be of a short duration. A windward leg of approximately 6 minutes and an overall race duration of about 20 minutes, excluding the pre-start, is preferred.

Shortening Course

In general, there is no time limit for completing a race. Courses should be shortened only in extraordinary circumstances, and then only after consulting with the umpires.

Abandoning a Race In Progress

A good Race Committee running a fleet race would not hesitate to abandon a race if it determined that an error, such as in the timing or display of a signal has occurred. That principle does not necessarily apply in match racing. Race Committees must be alert to the fact that abandoning a race, even before the starting signal can undo a significant advantage gained by one of the boats. However, if the Race Committee thinks it has made an error which may affect the outcome of a match, the race is best abandoned quickly in order that it can be re-sailed without delay. The guiding principle is that if the error would most certainly result in redress in form of a re-sail, the Race Committee saves time by abandoning immediately after the error is realised. It is preferable to consult with the umpires before abandoning.

If the wind shifts such that the boat do not have to tack on the first leg then the race should also be abandoned. The standard sailing instructions permit this. After rounding the first mark the race should only be abandoned in extra-ordinary circumstances as by then the leader would be prejudiced.

In very unusual circumstances, the umpires may recommend that a match should be abandoned. Although the decision to do so rests with the Principal Race Officer, they should give strong consideration to such a recommendation. See also Call MR L1.

The following is a guideline for when a match race should be abandoned in light or shifty winds:

In match racing there is normally not an overall time limit for a race. This is because the last thing you want to do is to have to abandon a race that is a bit too long and then find you have no time to run another one. This means that when deciding whether to abandon a match race due to insufficient wind, there is no absolute measure. There are two different approaches to this problem.

Both approaches should be seen as an extension of match race call MR L1 that gives other criteria for abandoning.

Approach 1. Focus on Consistency

A match race should be abandoned when:

- (a) At the preparatory signal, either boat does not make enough progress to be able to fulfil the entry requirements,
- (b) In the pre-start, boats are unable to circle and maintain steerage,
- (c) On the first beat, either boat sails into the zone around the windward mark without tacking after starting, or
- (d) Neither boat makes significant progress for two minutes.

The decision to abandon must be irrespective of the position of the match at the time. Even if one boat is ahead and the other has an outstanding penalty, the match must be abandoned if one of the above criteria is met. Otherwise the decision becomes; if Yellow wins the race will stand, but if Blue catches up we will abandon. The aim of the criteria is to reduce judgement in favour of consistency, and competitors have difficulties understanding that one match is abandoned while another match in the same conditions is not.

Approach 2. Focus on Judgement

The decision to abandon is solely the responsibility of the race committee; the umpires can suggest or recommend, but not decide. For the race committee, the criteria above are guidelines, and not directives or hard and fast rules. They must use discretion in the application of the criteria.

Abandonment must always reflect the fairness of the competition, so the longer a race continues, the less fair it is to abandon. Therefore, some of the criteria above are changing importance throughout a race. Criteria (d) is more applicable in the pre-start and on the first leg. It becomes less and less applicable on each succeeding leg.

H.4 Starting Lines

Length

As discussed below, boats have a limited time within which to enter the starting area and manoeuvre for position and control. The longer the starting line, the more of that limited time is lost as the boats sail towards each other. In addition, a long starting line may also affect the advantage of being the Yellow boat. For these reasons, it is suggested that the starting line be approximately 20-30 seconds in length. As an example, if a boat reaches along the starting line at 5 knots, it will travel approximately 2.5 meters in 1 second. In these conditions, the appropriate length starting line would be approximately 65 meters.

Once the race committee boat is on station, spend a few minutes observing the speed of the boats as they reach in the existing conditions. The race officer may find it helpful to ask a competitor to pass the stern of the race committee boat and reach along on starboard tack

while the race officer observes. That data may be used as a guide to set the starting line. Time the progress of boats reaching along the line to judge its angle and length. This will give the Race Committee the opportunity to confirm that the length is appropriate and make corrections as needed.

Angle

The angle of the starting line is just as important as its length. In fleet racing, it is preferred to establish a starting line that is square to the wind direction. The same principle applies in match racing, but not to the same degree. During the pre-start manoeuvring, the Race Committee should observe how the boats handle the first cross after entry. If the boat entering from the port end can consistently cross the boat entering from the starboard end, there is a problem with the starting line. Usually, the problem is the result of one or more of the following:

- the starboard end of the line is upwind of the port end
- the effect of current has not been properly taken into consideration
- the race committee boat anchor line is obstructing the boat entering from the starboard end
- the line flag is too far aft on the race committee boat

The Race Committee should adjust the starting line in this case by a combination of

- (1) moving the port end starting buoy to windward,
- (2) placing a sentinel on the anchor line, or
- (3) moving the line flag toward the bow of the race committee boat..

H.5 Starting Procedures

Starting System

The starting system is set out in rule C3. During a flight, each match will start at five minutes intervals, with the starting signal for one match serving as the warning signal for the next match.

A sample log for starting a flight of five matches is shown at the end of this part.

Flags

The Race Committee will be displaying many flags throughout the starting sequence. Extraneous flags, or flags too close to each other can be confusing to competitors. Avoid displaying any flags, which are not necessary to starting the race (such as a national ensign, club burgee, Race Committee flag, private signal and sponsor flags). Care should also be taken that each flag when displayed is separated both horizontally and vertically from other flags being displayed. Finally, the Race Committee should attempt to display each specific flag from the same location throughout the event.

Sound Signals

In many parts of the world, Race Committees use a gun or cannon to start races. Given the short starting line and the expense of ammunition, horns are acceptable except in extremely

windy conditions. Whistles should be avoided. The umpires will be using whistles and a whistle from the race committee boat may confuse the competitors.

It is quite common for a Race Committee to use a gun for the attention signal and then a horn for any other signalling.

Improper Entry

The Umpires and Wing Umpires will determine whether a boat was at her assigned end of the starting line at the preparatory signal. The Race Committee should not make any sound or visual signal if a boat has not complied with this requirement.

If there are no wing umpires and the race committee boat is the starting mark, the umpires of the last match may request that the race committee assist in judging whether the boat on starboard is on her assigned end at the time of the preparatory signal.

From the preparatory signal, each boat has two minutes within which to completely cross and clear the starting line for the first time from the course side. Once she has done so, she may sail anywhere she desires. If both boats have done so, no sound or visual signals should be made. If a boat has not done so, the Race Committee should make one sound signal and display the identification flag of the boat, which has not entered properly. If relevant, this signal is given two minutes before the starting signal. The flag should be removed after one minute or when the umpires have signalled the penalty, whichever comes first. Whenever the Race Committee realize that one (or both) of the boats have not entered correctly, they may give that information to the umpires on the radio, but should still give the signal and sound at the proper time.

Premature Starters

It is the responsibility of the Race Committee to notify the competitors and umpires when the hull, equipment or crew of a boat is on the course side of the starting line or its extensions at the starting signal. This is accomplished by one short sound signal and the display of coloured flags (yellow or blue) that correspond to the colour of the identification flag(s) of the boat(s) on the course side. Each flag should be removed the moment that boat returns completely to the pre-start side of the starting line or its extensions or after two minutes, whichever comes first. It is essential that the Race Committee have a procedure that will enable the display of recall flags within 1 or 2 seconds of the starting signal. In Match Racing, there are more claims for redress as a result of late recall signals than for any other reason.

Occasionally in match racing, both boats are under the starting line at the starting signal, but then later on they sail on the course side of the line (crossing the extension of the line) without ever having crossed the starting line. When this happens, the Race Committee must promptly display the ID flag (blue and/or yellow) - but they should not give any sound signals. The flag should be removed the moment the boat(s) returns completely to the pre-start side of the starting line or its extensions or after two minutes, whichever comes first.

Postponement

The Race Committee should postpone a starting sequence in progress only for a significant error or a substantial change in the weather conditions. The Race Committee must consider that a postponement will cancel any advantage one boat has gained, such as causing the other boat to have an outstanding penalty. The rule of thumb is 'if in doubt, don't

postpone.' In the event that a starting sequence is postponed, the next signal will be a new attention signal, displayed one minute after flag AP is removed (with one sound signal).

H.6 Course Changes

When and Where to Change Course

A Race Committee must always be alert to how the course configuration is affecting the competitors. Ideally, both the windward and downwind legs will be square. This provides the most opportunities for lead changes. If the boats spend substantially more time on one tack than the other, especially downwind, the course should probably be adjusted.

ISAF does not recommend that downwind legs be changed in match racing. Experience shows that the probability of encountering a prejudicial error is high, particularly since the race committee boat and finishing buoy must also be changed. On the other hand, upwind course changes are relatively simple and should be considered if the course needs adjustment rather than waiting until all boats racing have finished.

Signalling Procedure

Upwind course changes may be signalled at two locations.

For boats already racing, the Race Committee may signal a course change at the leeward mark. Since signals may also be made by the race committee boat (see below), it is very important for the Race Committee to station a boat as close as possible to the leeward mark. A Race Committee should never expect that it is able to signal a course change for one pair and remove the signal before the next pair arrives. For that reason, the Race Committee must use flags to designate the pairs to which the signal applies.

For boats not yet started, the Race Committee Signal boat may signal a change of the windward mark by displaying flag C with the preparatory signal for each pair to which the change applies and making several repetitive sound signals.

The new mark should be of a shape and/or colour that is easily distinguishable from the original mark. Should it be desirable to place the original mark in the same location as the new mark, the two marks may be tied together with a short lanyard and secured to the bottom with one set of ground tackle.

The ISAF Standard Sailing Instructions include further details on these procedures.

Mark Boat Procedures

Wind readings expressed by compass bearing are of limited value to the Principal Race Officer, who will be very busy while a match is in progress. It is recommended that the windward mark boat stations itself, drifting, directly upwind of the leeward mark, at the desired distance, whenever possible. The Principal Race Officer can then visualise quickly

- (1) the direction of the wind and
- (2) the potential need to effect a course change.

Moreover, the mark boat will be in the right location to deploy a new mark upon command. This procedure also eliminates the need to use the radio for reporting wind readings

H.7 Finishing

Finishing Line

The finishing line is the same as the starting line. The race committee boat and the starting/finishing buoy should be left in place. The race committee should resist any temptation to square the finishing line. With short races, there is seldom time to make such an adjustment. In fact, it is not unusual for boats to be finishing while others are starting.

Penalties

As a match approaches the finishing line, the umpires will advise the race committee boat if one of the boats (or both) must take a penalty before finishing. A boat required to take a penalty must lower the head of its spinnaker below the gooseneck, pass head-to-wind and then bear away to a course more than 90 degrees from the true wind direction before finishing.

One of the more common ways for a boat to take a penalty is for her to cross the finishing line at the pin, tack around the buoy, bear away to a downwind course and then re-cross the finishing line. Another common method of taking a penalty is for a boat to drop her spinnaker close to or on the finishing line, tack and then bear away onto a downwind course on the other tack and cross the finishing line. It is important that the umpires use a sound signal at the instant they decide the boat has completed her penalty. It is then a simple matter for the race committee to determine if the boat sails wholly on the course side of the line after the sound signal.

It is up to the race committee to determine whether or not a boat was completely (including the main boom and the top of the mast) on the course side of the finishing line after completing the penalty and before finishing. If she has not done so, she has not finished. In all other respects, the umpires will determine whether or not a boat has taken the penalty properly.

Signals

The blue flag or shape signifying that the committee boat is on station shall not be used in match racing (see rule C3.3). Unless the committee is in the process of starting later matches in the same flight, the only flag that should be visible as a boat approaches the finishing line is the line flag.

The race committee should advise the competitors and umpires which boat has finished first (after taking a penalty if required) by displaying her blue or yellow identification flag for a few seconds. The race committee should not make any sound signal as this may be confused with a signal from the umpires or starting signals for matches not yet started.

The display of the ID flag for the boat that finishes first does not have any meaning under the rules – it is merely a service to the competitors, umpires, spectators and media.

H.8 Scoring

The scoring system used in match racing is found in rules C10 and C11. It is advisable to consult with the chief umpire before posting final results or announcing which teams will advance to the next round. For graded events, the chief umpire is required to sign the results before they are submitted to ISAF for inclusion in the ranking lists. A sample score sheet is shown at the end of this part.

H.9 Race Committee and Umpires Equipment

Part J includes lists of equipment necessary for the umpires and race committee. The principal race officer and the chief umpire should determine well in advance of the event who will be responsible for ensuring the availability of the equipment.

SAMPLE STARTING SEQUENCE

FIVE MATCHES PER FLIGHT

TIME IN MINUTES	VISUAL SIGNAL	SOUND SIGNAL	MEANS
30	Flag F	Gun	Attention
26	Flag F removed	None	
25	Numeral pennant 1 for first Match	Horn	Warning
24	Flag P	Horn	Preparatory (begin entry time)
22	ID flag of boat not complied with C4.2	Horn (only if not comply with C4.2)	End of entry time
21	Remove flag P	Horn	1 minute to start
20	Remove pennant 1 a - display pennant 2	Horn	Start Match 1 - Warning Match 2
19	Flag P	Horn	Preparatory (begin entry time)
17	ID flag of boat not complied with C4.2	Horn (only if not comply with C4.2)	End of entry time
16	Remove flag P	Horn	1 minute to start
15	Remove pennant 2 - display pennant 3	Horn	Start Match 2 - Warning Match 3
14	Flag P	Horn	Preparatory (begin entry time)
12	ID flag of boat not complied with C4.2	Horn (only if not comply with C4.2)	End of entry time
11	Remove flag P	Horn	1 minute to start
10	Remove pennant 3 - display pennant 4	Horn	Start Match 3 - Warning Match 4
9	Flag P	Horn	Preparatory (begin entry time)
7	ID flag of boat not complied with C4.2	Horn (only if not comply with C4.2)	End of entry time
6	Remove flag P	Horn	1 minute to start
5	Remove pennant 4 - display pennant 5	Horn	Start Match 4 - Warning Match 5
4	Flag P	Horn	Preparatory (begin entry time)
2	ID flag of boat not complied with C4.2	Horn (only if not comply with C4.2)	End of entry time
1	Remove flag P	Horn	1 minute to start
0	Remove pennant 5 and Flag P	Horn	Start Match 5

SAMPLE SCORE SHEET

ROUND ROBIN

TEN TEAMS

TEAMS	1	2	3	4	5	6	7	8	9	10	Score	Ranking
1												
2												
3												
4												
5												
6												
7												
8												
9												
10												



INTERNATIONAL UMPIRES' AND MATCH RACING MANUAL

SECTION I

Reserved for Future Use



INTERNATIONAL UMPIRES AND MATCH RACING MANUAL

SECTION J

Suggested Umpire and Race Committee Equipment

Contents	Page
J Suggested Umpire and Race Management Equipment	
J.1 Competitor Boats	J 2
J.2 Umpire Flags	J 2
J.3 Penalty Shapes and Flags	J 2
J.4 RC Signal Boat Flags	J 3
J.5 Umpires Equipment	J 3
J.6 Marks	J 3
J.7 Umpire Boats	J 3
J.8 Spares	J 3
Supplement for Flags v Shapes	J 4

Note: Section T of The ISAF Race Management Manual includes information about this. The Manual can be downloaded from the ISAF website: Race Officials, International Race Officers, Document Library

J.1 Competitor Boats

Each team should be provided with a set of 5 flags containing:

- Y (Boat vs boat protests)
- Red (red-flag protests)
- Green flag or flag L (Breakdown)
- Blue (ID-flag)
- Yellow (ID-flag)

Y flags should be approx. 30 cm square, on a pole.

Red and green flags / L flags should be approx. 30 cm square, and capable of being attached to a shroud or backstay.

Blue and Yellow flags should be at least 40 cm square, and capable of being attached to a backstay..

J.2 Umpire Flags

The Event Organiser is usually responsible for supplying umpire flags. Each umpire and wing boat should be equipped with a set of 5 (or 7) flags:

- Green and white
- Blue (2 if flags are used instead of shapes)
- Yellow (2 if flags are used instead of shapes)
- Red
- Black

All of the flags should be at least 40 cm square and mounted on poles approx. 80 cm long.

Yellow and Blue flags should be of the same colour as the yellow and blue flags provided to competitors.

Green and white flags should preferably consist of four squares, alternating between green and white.

In addition to the flags listed above, each umpire boat may be identified by a white flag bearing 'U', 'IU' or 'Umpire' (in black).

Wing boats may be identified by a white flag bearing the word 'Wing' (in black).

J.3 Penalty Flags or shapes

More and more events use flags instead of penalty shapes. A document explaining the system with flags instead of shapes can be found at the end of this Part of the Manual.

When events use shapes, each umpire boat should be provided with four penalty shapes (2 blue and 2 yellow) and a pole on which to display them. Small fish buoys painted bright yellow and bright blue are an inexpensive solution. Painted foam or wooden shapes have also been used effectively. The shapes need to be big enough to be clearly visible at a distance. The pole can be a small dowel that is taped onto a conspicuous location. Test that the shortest umpire can reach to fit the penalty shapes on the pole.

J.4 RC Signal Boat Flags

In addition to the usual complement of flags, the RC signal boat must be equipped with yellow and blue recall flags (of the same colour as the flags provided to competitors), pennants to distinguish the flight and match (usually numeral pennants), 3rd Substitute and flags F and P.

J.5 Umpire Equipment

Each umpire boat should be equipped with a VHF radio (the chief umpire should normally have one extra radio for communication with the race committee or to enable communication with other groups like media, bosun etc). Umpires always provide their own whistles, and sometimes radios, too, but the Chief Umpire and the Principal Race Officer should discuss this before the event.

The Chief Umpire should also be made aware whether there is a requirement in the country or club where the event take place for a license to drive powerboats. If so, all umpires need to be advised about this before they arrive at the venue.

In addition, there may be a requirement for carrying or wearing personal flotation devices. Should there be such a requirement, the umpires need to know in advance whether this will be provided or they have to bring their own equipment.

J.6 Marks

It is strongly suggested that the starting/finishing mark be of a shape and/or colour that is distinguishable from the leeward mark. Likewise, a new (changed) mark should be of a different shape and/or colour as an original mark.

J.7 Umpire Boats

Umpire boats should be easily manoeuvred, preferably open with centre consoles. A boat of approximately 5 to 7 meters that leaves little wake is ideal. Large boats are not desirable because they cannot be manoeuvred sufficiently to follow the action. Small boats, in which the umpires cannot stand, should be avoided if possible.

Wing boats should, if possible, be of the same size and type as the umpire boats. If necessary, smaller boats, in which the wing umpires sit, may be used as long as the boats are fast and easily manoeuvrable.

J.8 Spares

It is helpful to maintain a set of spare competitor and umpire flags. Especially Y flags are often lost in the water by competitors. The spares can be left in the control of the Chief Umpire throughout the event.

Supplement for Flags v Shapes

<p>History. With the advent of delayed penalties there needed to be a reliable system of signalling outstanding penalties both for the competitors and the spectators. Prior to 2002 the accepted method was to display a coloured shape on a pole in the umpire boat corresponding to the colour of the boat carrying the outstanding penalty. In 2002 some events introduced the display of coloured flags instead of the coloured shapes, this method has now become the accepted method of signalling outstanding penalties.</p>	
<p>Penalty situation. (we are assuming the originally penalised boat is yellow)</p>	<p>Umpire actions?</p>
<p>Yellow is penalised when there are no outstanding penalties.</p>	<p>The umpires blow their whistle and display the Yellow flag.</p> <p>While keeping the Yellow flag displayed transfer the flag to the flag holder.</p>
<p>Yellow completes her penalty.</p>	<p>One <u>short</u> blast on the whistle and remove the Yellow flag.</p>
<p>Blue is penalised, while Yellow has an outstanding penalty, C5.2</p>	<p>Blow the whistle and display the Blue flag, remove both the Blue and the Yellow flags at the same time.</p>
<p>Blue is penalised with a Red flag, C5.3, while Yellow has an outstanding penalty.</p>	<p>Blow the whistle and display the Blue flag with the Red flag.</p> <p>Keep both the Blue and Red flags displayed until blue has completed her penalty.</p> <p>The Yellow penalty is not offset so Yellow flag remains.</p>
<p>Blue is penalised with a double penalty while Yellow has an outstanding penalty.</p>	<p>Blow the whistle and display the Blue flag. Remove the Yellow flag Blow the whistle and display the Blue flag again While keeping the Blue flag displayed transfer it to the flag holder.</p>
<p>The umpires decide to 'Black Flag' Blue while Yellow has an outstanding penalty.</p>	<p>Remove the Yellow flag (without sound signals). Blow the whistle and display the Blue flag together with the Black flag.</p>
<p>Blue and Yellow are penalised for the same incident while Yellow has an outstanding penalty</p>	<p>Blow the whistle and display Blue and Yellow flags well clear of the outstanding Yellow flag. Drop both Blue and Yellow flags after about 10 seconds leaving the original Yellow flag displayed.</p>
<p>Yellow is penalised while she has an outstanding penalty.</p>	<p>Blow the whistle and display the Yellow flag. Keep the flag displayed until Yellow has taken her second penalty, (If early in the pre-start you may need to find a way to leave both flags displayed without having to hold one of them.)</p>
<p>Yellow is penalised while she has two outstanding penalties. (This might be a third penalty or a double penalty with one outstanding.)</p>	<p>Keep both Yellow flags displayed, blow the whistle and display the Black Flag C5.4.</p>

Advantages of using flags	Disadvantages of using flags
<p>The umpire does not have to reach into the bottom of the boat to get the shape.</p> <p>The umpire can keep umpiring while placing the flag into the holder</p> <p>The transfer is a one handed operation adding to umpire safety</p> <p>The flag is more distinctive (does not resemble a hat or similar)</p> <p>Flags are easier to store on the boat and are less likely to blow over the side</p> <p>The holder pole can be shorter than that needed for shapes as the flag sticks up above the pole</p> <p>Umpire kit easier to store and transport between events.</p>	<p>Can be noisy when displayed, generally not worse than the engine noise</p> <p>Organisers need to supply more umpire flags (a one time cost)</p> <p>Umpires need to avoid confusing signals. For instance, signalling a twin penalty when an outstanding penalty is displayed.</p>

Hints

The same pole as is presently used for the shapes can easily be adapted to hold the flags by putting a bolt through the pole approximately 200 mm (8") down from the top of the pole.

If the pole presently used for the shapes has a smaller internal diameter sleeve a larger diameter tube over the tube *or* reduce the flag tube diameter by fitting a smaller diameter sleeve inside the flag tube.

Two poles per umpire boat do help in case of two penalties to the same boat in the pre-start.

Ensure that the flags themselves are above the umpire's heads, even when the umpires are standing, but not so high that it is a stretch to put the flag in place (unsafe).

Support poles will be eye height for some. Ensure they are placed to avoid risk of eye injury.

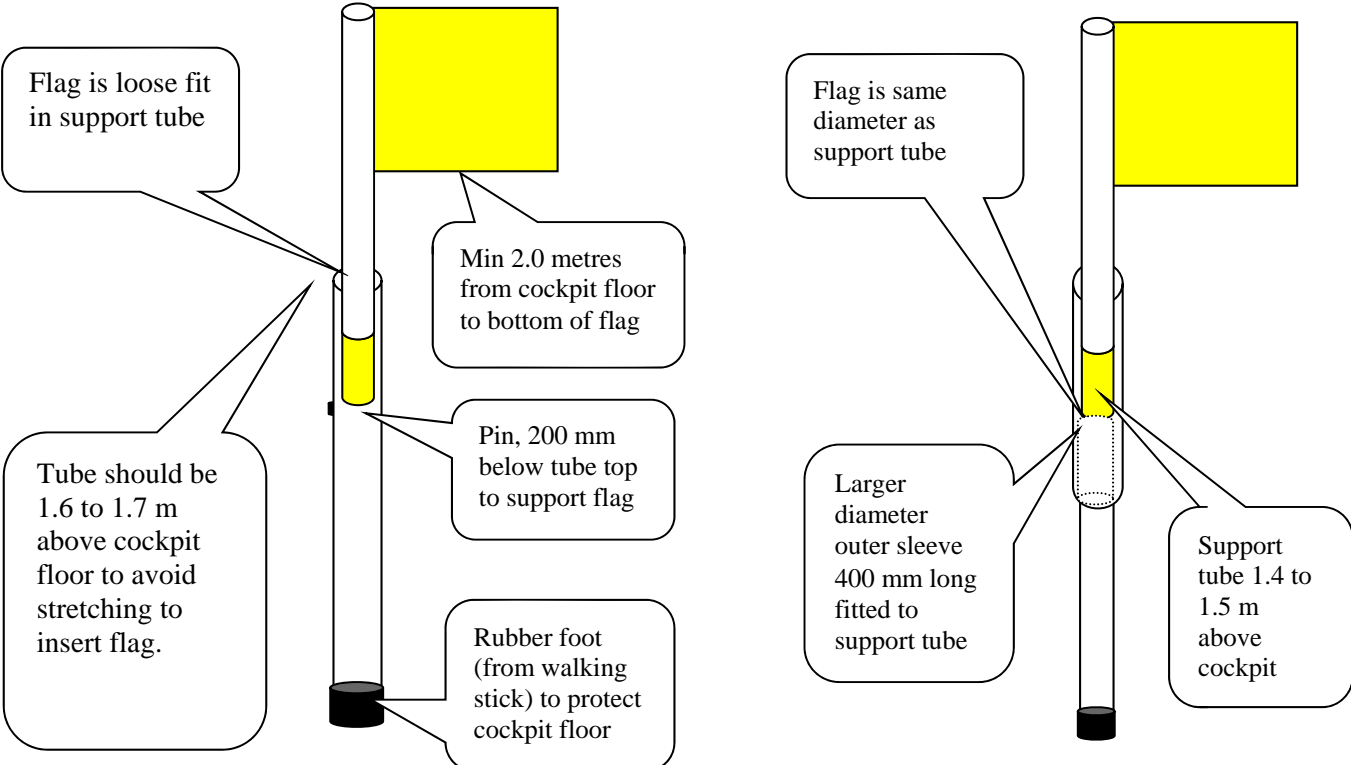

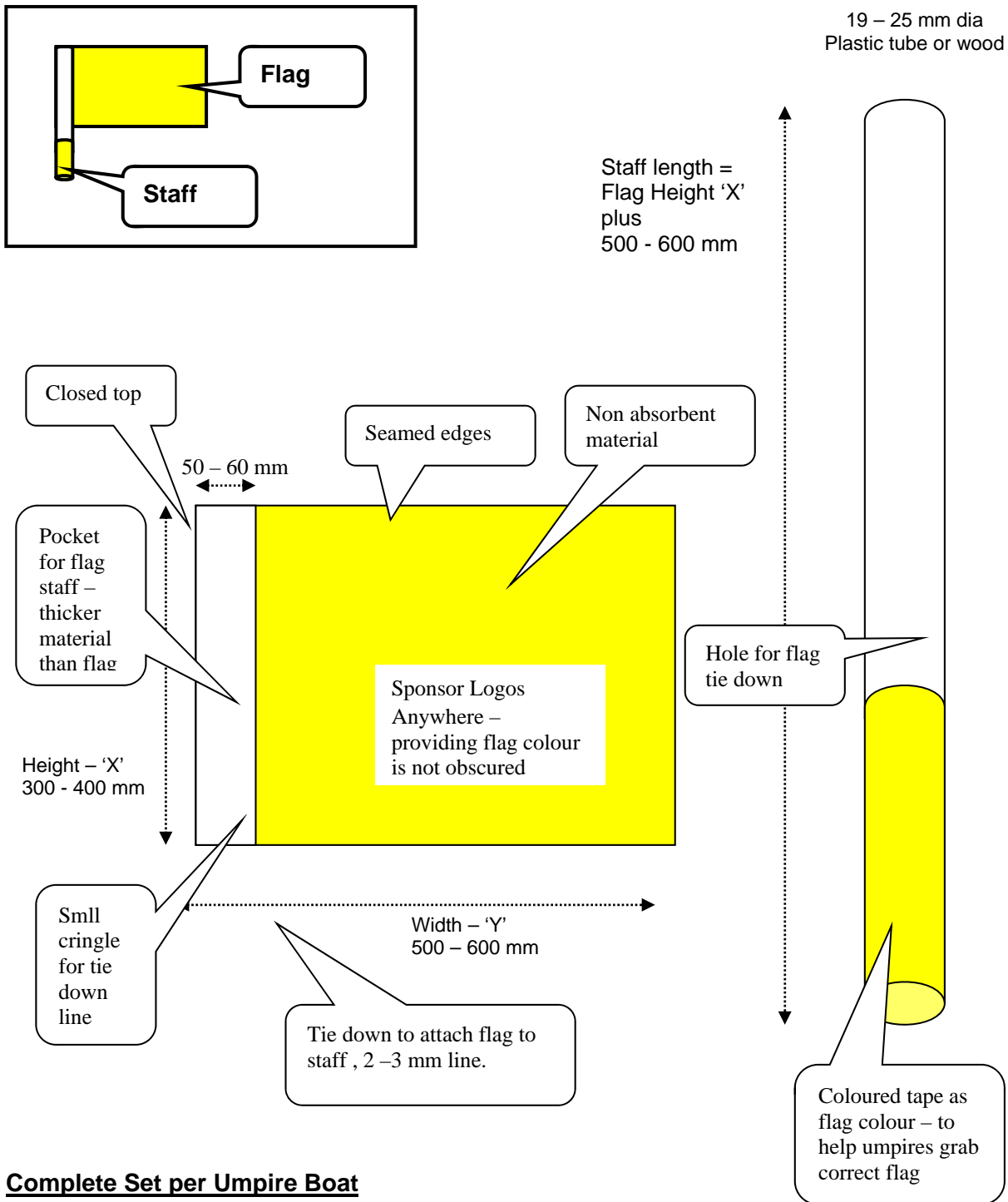

Complete Set per Umpire Boat

Provide one set per umpire boat + spare set.

Green & White

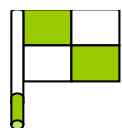

2 x Yellow

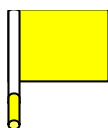

2 x Blue

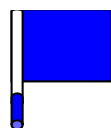

Red

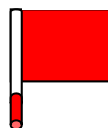

Black



Note: Translucent materials, such as spinnaker cloth, show colours much better. For Green & White - do not use white patches on green cloth as they do not display well, especially on television.



INTERNATIONAL UMPIRES' AND MATCH RACING MANUAL

SECTION K

ISAF Standard Match Racing Notice of Race

NOTE: This document will change frequently. Please check the ISAF website (www.sailing.org) for the most recent edition.

You will find it at
www.sailing.org/raceofficials/eventorganizers/nor.php



INTERNATIONAL UMPIRES' AND MATCH RACING MANUAL

SECTION L

ISAF Standard Match Racing Sailing Instructions

NOTE: This document will change frequently. Please check the ISAF website (www.sailing.org) for the most recent edition.

You will find it at
www.sailing.org/raceofficials/eventorganizers/nor.php



INTERNATIONAL UMPIRES' AND RACE MANAGEMENT MANUAL

SECTION M

Competition Schedules or Pairing Lists

Contents

Page

M	Competition Schedules or ‘Pairing Lists’	
M.1	Recommended Criteria for Dividing Competitors into Groups (or Pools)	M 2
M 2	Recommended Criteria for Round Robin Pairing Lists	M 2
M.3	Discussion on Competition Format	M 3
M.4	Some Examples of Pairing Lists	M 6
M.5	SI for 12 Skippers 6 Boats – short Round Robin	M 11
M.6	Tie Break Sail Offs	M 13

This part of the manual contains criteria for round robin pairing lists, a discussion on competition format, examples of pairing lists, an example of a knock-out table and also examples of how to organise tie - sail offs.

While the most common pairing lists are detailed here, they are only examples of a variety of possible options. Many others can be constructed, but we advise against any change unless there is a very good reason to do so.

For 12 competitors or less, a double round robin is recommended, followed by quarter finals, semi-finals and finals. There are various formats for quarter- and semi-finals, some of which give greater weight to performance in the round robin.

It is recommended that, should there be more than 12 competitors, groups (or pools) should be formed, e.g. for 16 competitors, form two groups of 8, each group to sail its own single or double round robin. The top skippers from each group would then sail a knockout series or semi-finals/finals.

By selecting the top three competitors from each pool it is possible to hold a quarter-final round robin series in five flights:

Flight Match	1stQ		2ndQ		3rdQ		4thQ		5thQ	
1st	2ndB	3rdB	3rdA	2ndA	3rdB	2ndA	1stB	3rdB	3rdB	3rdA
2nd	3rdA	1stA	1stA	3rdB	1stB	3rdA	3rdA	2ndB	2ndA	2ndB
3rd	2ndA	1stB	2ndB	1stB	2ndB	1stA	2ndA	1stA	1stA	1stB

The first four skippers of the quarter finals would then enter the semi-finals.

If time permits, there should be finals and petit-finals so that it is possible to complete an event ranking for all competitors.

M.1 Recommended Criteria for Dividing Competitors into Groups (or Pools)

When dividing competitors into groups event organizers must attempt to balance the groups. The following give some examples. Note that the number indicates the relative position of each competitor in the event, based on the ISAF Ranking List 30 days before the event.

2 groups of 4 skippers		2 groups of 5 skippers		2 groups of 6 skippers		3 groups of 4 skippers			3 groups of 5 skippers			4 groups of 4 skippers			
A	B	A	B	A	B	A	B	C	A	B	C	A	B	C	D
1	2	1	2	1	2	1	2	3	1	2	3	1	2	3	4
4	3	4	3	4	3	6	5	4	6	5	4	8	7	6	5
5	6	5	6	5	6	7	8	9	7	8	9	9	10	11	12
8	7	8	7	8	7	12	11	10	12	11	10	16	15	14	13
		9	10	9	10				13	14	15				
				12	11										

M.2 Recommended Criteria for Round Robin Pairing Lists

Principal Criteria in Order of Priority:

1. Each skipper sails each other skipper once.
2. When there is an even number of flights, each skipper has the same number of port and starboard assignments.

When there is an odd number of flights, the first half of the skippers will have one more starboard assignment.

4. *No skipper in the last match in a flight should be in the first match of the next flight.*

No skipper should have more than two consecutive port or starboard assignments.

6. *Each skipper should be assigned to match 1, match 2, etc. in a flight as equally as possible.*

7. *In flights with five or more matches no skipper should be in the next-to-last match in a flight and then in the first match of the next flight.*

8. *If possible, a skipper should be starboard when meeting the nearest lower ranked skipper (i.e. #1 will be starboard against 2, #3 will be starboard against 4).*

9. *Close ranked skippers meet in the last flight.*

Extra Criteria when Boat Changes are Required:

10. *Minimum number of changes.*

11. *Skippers in the last match of a flight do not change boats.*

12. *Skippers in new boats do not sail in the first match of the next flight.*

(Note: 11 and 12 override 6 when changes are required.)

Extra Criteria when there are more boats than matches:

13. *Skippers have a reasonable sequence of matches and blanks*

M.3 Discussion on Competition Format

Decisive factors when choosing a format:

When deciding on the competition format, organizers should consider all the 'players': the competitors of course, but also sponsors, on-the-water and on-shore spectators, officials, boat owners, the media, etc.

Other constraints to be considered: the weather, the time available, condition of the boats, etc.

There are many formats to choose from. Some of the advantages and disadvantages of the various options are listed below.

Round Robins

The basis of most match racing events is the round robin. Some events consist of just a single or double round robin. Others start with a round robin and then move on to knock-out competitions, usually semi-finals and finals.

The round robin is the only format in which every competitor sails against every other competitor. Each competitor sails the same number of races, and knows the minimum number of races that he will be allowed to sail when he enters the event.

If there is an even number of competitors, each will sail an odd number of races, which means that some will have more starts from the port end of the line and others from the starboard end, which may be considered inequitable. One way to avoid this is to have a

double round robin, merely reversing the side of start between each pair of competitors for the second round.

If an event consists of a single round robin, it is hard to create a result that is equitable to all competitors if for any reason the round robin cannot be completed.

Spectator appeal can be increased by seeding the competitors and arranging that the best competitors sail against each other at the end of the round. In theory this should be the race which produces the winner and runner-up.

Organizers wishing to seed competitors should first consider which criteria to use for seeding. The ISAF Match Race Ranking List is the natural tool for this.

A critical factor is time. Organizers must estimate the amount of time necessary to complete the programme. It is not only essential to get through the event at a fast enough pace, but consideration should also be given to the stamina of all concerned. For example, after umpiring 8 intense matches, the performance of most umpires will start to deteriorate rapidly.

The number of matches in a round robin is equal to $n(n-1)/2$, where n equals the number of competitors, so a single round robin for 10 competitors would result in $10 \times 9 / 2 = 45$ matches. If 10 boats are available, this results in 9 flights. With each match approximately taking 20 minutes, a flight consisting of 5 matches will require a period of 50 minutes. Eight or nine flights a day is a reasonable achievement.

Groups (or 'half round robins')

If the number of competitors is such that even a single round robin would put the event in jeopardy, the competitors may be divided into two groups.

With 10 competitors, each group now requires only $5(5-1)/2 = 10$ matches to complete their own round robin, giving 20 matches in all, less than half the full round robin total. The obvious disadvantage of this approach is that each competitor does not get to race against each other competitor.

Dividing the competitors into two groups such that there is a balance of ability in each half may be difficult, but again, the ISAF Ranking List or any other national ranking list, will help. Another problem is that with groups there is a strong chance of ending up with a number of competitors with the same number of points - and with the need for a mechanism for breaking the tie.

Knock-out competitions

The problem of competitors ending up with the same number of points is a major disadvantage of any round robin format, which is why the round robin part of the event is usually followed by some form of knockout competition involving the higher placed competitors.

Often (almost always) the finals of an event is a knock-out competition.

Statistics of the victories and losses by each of the boats (NOT the skippers) during the round robins, may be useful for the purpose of choosing the four boats to be used for the semi-finals and finals.

During the semi-finals, the highest scoring skipper in each of the semi-finals will enter starboard (yellow) one more time than his opponent (1st, 3rd and 5th matches as opposed to 2nd and 4th matches).

Tradition suggests giving the winner (W) of the round robin (or quarter-finals) the privilege of choosing his opponent (O). The better (B) of the two other boats will meet the last (L) remaining boat.

Flight ⇒ Match ↓	1SF		2SF		3SF		4SF		5SF	
1	O	W	W	O	O	W	W	O	O	W
2	L	B	B	L	L	B	B	L	L	B

The finals should be scheduled in such a way that the last match of the event should be the last match of the final for 1st - 2nd place i.e. any concurrent petit final should be run as the first match of the flight.

Sometimes during the semi-finals and the finals the skippers will have to change boats. The best solution would be a change after each match (boats remaining with the same colour for all the finals) but this system takes a lot of time. The ISAF Standard Sailing Instructions suggests to change boats after each odd-numbered match.

This procedure would be required, of course, only when the organisers provide the boats.

With six boats a suggested schedule is as follows:

Flight ⇒ Match ↓	1F		2F		3F		4F		5F	
1	6	5	5	6	6	5	Wsf	Wsf	Wsf	Wsf
2	Lsf	Lsf	Lsf	Lsf	Lsf	Lsf				
3	Wsf	Wsf	Wsf	Wsf	Wsf	Wsf				

In the table above, L indicates "loser"; W indicates "winner". After the semi-finals there are two winners and two losers.

The most equitable solution is to make a draw: The winner of the draw chooses side or boat for the first match, the loser of the draw chooses what is left (side or boat). The boats will then exchange side after every match and boats after every odd number match.

Matches to determine fifth and sixth positions could be sailed either separately, during the semi-final series, or as shown here – with the final series.

M.4 Some Examples of Pairing List

4 skippers – 4 boats						
Flight ⇒	1		2		3	
Match ⇓						
1	3	2	3	1	4	3
2	1	4	4	2	2	1

4 skippers – 4 boats – double round robin																		
Flight ⇒	1			2			3			4			5			6		
Match ⇓																		
1	4	1	1	3	1	2	3	2	4	2	4	3	4	3	4	3		
2	2	3	2	4	3	4	1	4	3	1	2	1	2	1	2	1		

5 skippers – 5 boats										
Flight ⇒	1		2		3		4		5	
Match ⇓										
1	2	5	3	1	4	2	1	5	4	3
2	1	4	5	4	5	3	3	2	2	1
Bye	3		2		1		4		5	

5 skippers – 5 boats – double round robin																				
Flight ⇒	1		2		3		4		5		6		7		8		9		10	
Match ⇓																				
1	5	2	1	3	2	4	5	1	1	2	2	5	3	1	4	2	1	5	4	3
2	4	1	4	5	3	5	2	3	3	4	1	4	5	4	5	3	3	2	2	1
Bye	3		2		1		4		5		3		2		1		4		5	

6 skippers – 6 boats										
Flight ⇒	1		2		3		4		5	
Match ⇓										
1	5	4	5	3	3	2	6	3	6	5
2	3	1	2	4	4	6	5	2	4	3
3	6	2	1	6	1	5	4	1	2	1

6 skippers – 6 boats – double round robin																				
Flight ⇒	1		2		3		4		5		6		7		8		9		10	
Match ⇓																				
1	4	5	3	5	2	3	3	6	5	6	5	4	5	3	3	2	6	3	6	5
2	1	3	2	4	4	6	2	5	1	2	3	1	4	2	6	4	5	2	4	3
3	6	2	6	1	5	1	1	4	3	4	2	6	1	6	1	5	4	1	2	1

Flight ⇒ Match ↓	6 skippers - 4 boats															
	Flight 1				Flight 2				Flight 3				Flight 4			
	boat	sk	sk	boat	boat	sk	sk	boat	boat	sk	sk	boat	boat	sk	sk	boat
Match 1	a	5	4	b	a	5	3	d	a	4	2	d	c	6	5	d
Match 2	d	3	1	c	b	2	6	c	b	1	6	c	a	4	3	b
	Flight 5				Flight 6				Flight 7				Flight 8			
	boat	sk	sk	boat	boat	sk	sk	boat	boat	sk	sk	boat	boat	sk	sk	boat
Match 1	b	3	2	c	a	6	4	c	a	2	5	b	a	2	1	d
Match 2	a	1	5	d					d	1	4	c	b	6	3	c

7 skippers – 7 boats														Comments	
Flight ⇒ Match ↓	1		2		3		4		5		6		7		In case of a double Round Robin, use this table for the second round, but reverse blue and yellow from the first round.
1	6	3	5	3	5	2	6	2	4	1	7	5	6	5	
2	5	4	1	7	1	6	1	5	7	6	2	4	4	3	
3	2	7	4	6	7	4	3	7	3	2	3	1	2	1	
Bye	1		2		3		4		5		6		7		

8 skippers – 8 boats														Comments	
Flight ⇒ Match ↓	1		2		3		4		5		6		7		In case of a double Round Robin, use this table for the second round, but reverse blue and yellow from the first round.
1	6	3	3	5	1	6	8	4	4	1	7	5	8	7	
2	5	4	1	7	8	3	6	2	5	8	8	6	6	5	
3	2	7	2	8	7	4	5	1	7	6	3	1	4	3	
4	1	8	6	4	5	2	7	3	3	2	4	2	2	1	

8 skippers – 2 groups of 4 boats (same class in different conditions or two classes)																					
Flight ⇒ Match ↓	1			2			3			4			5			6			7		
	(*)			(*)			(*)			(*)			(*)			(*)			(*)		
1	A	4	1	A	5	1	A	5	4	A	1	6	A	6	4	A	4	2	A	4	3
2	A	8	5	A	8	4	A	1	8	A	7	4	A	1	7	A	3	1	A	2	1
3	B	2	7	B	6	2	B	7	6	B	3	8	B	2	8	B	6	5	B	8	6
4	B	6	3	B	7	3	B	3	2	B	5	2	B	5	3	B	8	7	B	7	5
(*) indicates the groups of boats. After flight # 3 swap 1 with 4; 5 with 6; 8 with 7; 2 with 3 After flight # 5 swap 6 with 2; 7 with 3 .										In case of a double Round Robin, use this table for the second round, but reverse blue and yellow, and change boat groups from the first round.											

8 skippers - 4 boats																
Flight ⇒ Match ↓	Flight 1				Flight 2				Flight 3				Flight 4			
	boat	sk	sk	boat	boat	sk	sk	boat	boat	sk	sk	boat	boat	sk	sk	boat
Match 1	a	5	4	b	a	5	1	c	b	4	1	c	a	6	3	b
Match 2	c	1	8	d	d	8	4	b	d	8	5	a	c	2	7	d
	Flight 5				Flight 6				Flight 7				Flight 8			
	boat	sk	sk	boat	boat	sk	sk	boat	boat	sk	sk	boat	boat	sk	sk	boat
Match 1	d	7	6	a	d	7	3	b	a	6	4		a	6	5	b
Match 2	b	3	2	c	a	6	2	c	d	7	5	b	d	7	4	c
	Flight 9				Flight 10				Flight 11				Flight 12			
	boat	sk	sk	boat	boat	sk	sk	boat	boat	sk	sk	boat	boat	sk	sk	boat
Match 1	c	5	3	d	d	3	8	b	d	1	7	a	b	8	7	a
Match 2	a	2	8	b	c	5	2	a	b	8	6	c	d	1	6	c
	Flight 13				Flight 14											
	boat	sk	sk	boat	boat	sk	sk	boat								
Match 1	c	3	1	a	d	4	3	c								
Match 2	d	4	2	b	b	2	1	a								

8 skippers – 6 boats																				
Flight ⇒ Match ↓	1		2		3		4		5		6		7		8		9		10	
1	6	3	5	3	7	5	7	3	6	2	8	6	1	8	8	5	5	1	6	5
2	5	4	7	6	3	2	6	1	1	7	3	1	5	2	1	4	8	4	8	7
3	2	7	4	2	4	6	2	8	3	8	7	4	4	3					2	1

Changes after flight 3, flight 5, flight 6, and flight 9.

9 skippers – 9 boats																		
Flight ⇒ Match ↓	1		2		3		4		5		6		7		8		9	
1	3	1	9	6	4	9	5	2	3	9	1	8	4	2	8	5	8	7
2	9	8	7	4	2	8	7	3	8	4	6	4	9	7	6	3	6	5
3	7	6	3	2	5	3	1	9	6	2	2	7	3	8	4	1	4	3
4	5	4	5	1	1	7	8	6	7	5	9	5	1	6	2	9	2	1
Bye	2		8		6		4		1		3		5		7		9	

In case of a double Round Robin, use this table for the second round, but reverse blue and yellow from first round.

10 skippers – 10 boats																		
Flight ⇒ Match ↓	1		2		3		4		5		6		7		8		9	
1	9	4	5	2	3	9	1	8	4	2	10	7	3	1	10	8	10	9
2	2	8	7	3	1	10	6	4	9	7	8	5	2	10	9	6	8	7
3	5	3	1	9	8	4	7	2	10	5	6	3	9	8	7	4	6	5
4	1	7	4	10	6	2	9	5	8	3	4	1	7	6	3	2	4	3
5	10	6	8	6	7	5	3	10	6	1	2	9	5	4	5	1	2	1

In case of a double Round Robin, use this table for the second round, but reverse blue and yellow from first round.

10 skippers – 6 boats																				
Flight ⇒ Match ↓	1		2		3		4		5		6		7		8		9		10	
1	9	4	8	4	1	8	7	3	6	3	9	7	8	3	3	5	7	2	10	5
2	2	8	1	9	10	4	6	1	7	5	3	10	5	9	1	7	6	10	9	8
3	1	10	2	10	2	9	8	5	4	1	5	2	10	7	8	6	9	3	7	6

10 skippers – 6 boats, continued										
Flight ⇒ Match ↓	11		12		13		14		15	
1	10	8	8	7	5	4	4	6	6	5
2	7	4	4	2	6	2	5	1	4	3
3	9	6	10	9	3	1	3	2	2	1

10 skippers – 10 boats																		
Flight ⇒ Match ↓	1		2		3		4		5		6		7		8		9	
1	1	9	1	8	9	5	9	8	9	4	10	8	2	8	4	10	10	9
2	8	4	5	4	4	1	5	1	8	5	6	1	3	1	5	3	8	7
3	2	10	7	2	6	2	7	3	3	2	5	2	6	4	2	9	6	5
4	6	3	3	10	10	7	10	6	7	6	3	9	10	5	1	7	4	3
5	7	5	9	6	8	3	4	2	1	10	7	4	9	7	8	6	2	1

This is a special table for places with wind or weather problems.
 Skippers are divided in two groups. After five flights, it is possible to rank the competitors in the two groups and organise a quick final (1-1, 2-2....). When this becomes necessary the **bold typed matches** will be disregarded. If the conditions are good, the full round will be completed.
 The groups are: A: 1 – 4 – 5 – 8 – 9 B: 2 – 3 – 6 – 7 – 10

12 skippers – 6 boats – full Round Robin

After Flight 10, a single Round Robin in two groups have been completed. There are 5 complete boat changes during the full Round Robin.

	1	2	3	4	5	c h a n g e	6	7	8	9	10	c h a n g e	11
Match 1	4 - 12	12 - 1	5 - 12	5 - 4	9 - 5		10 - 2	10 - 7	10 - 3	7 - 3	11 - 7		2 - 12
Match 2	1 - 5	8 - 5	8 - 4	12 - 9	12 - 8		7 - 6	6 - 3	7 - 2	11 - 10	6 - 10		3 - 8
Match 3	9 - 8	9 - 4	1 - 9	8 - 1	4 - 1		3 - 11	2 - 11	11 - 6	2 - 6	3 - 2		9 - 6

	12	13	c h a n g e	14	15	16	c h a n g e	17	18	19	c h a n g e	20	21	22
Match 1	8 - 2	2 - 9		8 - 7	9 - 7	12 - 7		10 - 4	4 - 11	1 - 11		3 - 1	5 - 3	6 - 5
Match 2	9 - 3	8 - 6		11 - 9	12 - 11	10 - 9		11 - 5	1 - 10	7 - 4		5 - 2	1 - 6	4 - 3
Match 3	6 - 12	3 - 12		12 - 10	10 - 8	11 - 8		7 - 1	7 - 5	5 - 10		6 - 4	4 - 2	2 - 1

12 skippers – 6 boats – two groups

(one round – in case of a double round, this is the second, reverse for first)

Flight ⇒ Match ↓	1 group 1		2 group 1		3 group 1		4 group 1		5 group 1		6 group 2		7 group 2		8 group 2		9 group 2		10 group 2	
1	9	4	9	5	5	1	5	4	12	9	10	3	10	6	6	2	7	11	11	10
2	12	5	1	12	12	4	1	9	8	5	11	6	2	11	11	3	2	10	7	6
3	8	1	4	8	9	8	8	12	4	1	7	2	3	7	10	7	6	3	3	2

12 Skippers - 12 Boats

Flight ⇒ Match ↓	1		2		3		4		5		6		7		8		9		10		11	
1	12	2	5	4	8	3	1	9	10	6	1	7	6	1	12	7	3	2	6	8	9	10
2	6	4	8	10	4	7	2	10	8	1	11	3	7	11	3	9	10	12	12	9	4	3
3	3	5	2	11	9	2	12	6	11	4	9	6	10	3	5	1	8	5	10	11	7	8
4	9	8	6	3	10	1	4	8	7	2	10	5	8	12	6	2	7	6	2	4	11	12
5	7	10	7	9	12	5	5	11	3	12	12	4	4	9	11	8	9	11	1	3	5	6
6	11	1	1	12	11	6	3	7	9	5	8	2	2	5	4	10	1	4	5	7	2	1

16 Skippers - 8 Boats – Group 1

Flight ⇒ Match ↓	1		2		3		4		5		6		7	
1	12	5	5	9	16	5	16	8	8	1	13	9	16	13
2	9	8	1	13	1	12	12	4	9	16	16	12	12	9
3	4	13	4	16	13	8	9	1	13	12	5	1	8	5
4	1	16	12	8	9	4	13	5	5	4	8	4	4	1

16 Skippers - 8 Boats – Group 2

Flight ⇒ Match ↓	8		9		10		11		12		13		14	
1	11	6	6	10	15	6	15	7	7	2	14	10	15	14
2	10	7	2	14	2	11	11	3	10	15	15	11	11	10
3	3	14	3	15	14	7	10	2	14	11	6	2	7	6
4	2	15	11	7	10	3	14	6	6	3	7	3	3	2

•

M.5 SI for 12 skippers 6 boats – short Round Robin

EVENT FORMAT

B1. FIRST STAGE - Round Robin I

- (a) Skippers will be divided into two (2) groups using the ISAF Match Race Sailing ranking list as is 30 days before the event.
- (b) Each group will sail a Round Robin - each skipper sails each other skipper in his group once.
- (c) The three (3) highest scoring skippers from each group shall qualify for the next round. If there is an unresolved tie between the qualified skippers their pairing shall be determined by a draw.

B2. SECOND STAGE - Round Robin II

- (a) Each qualified skipper from one group sails each of the qualified skipper from the other group once in a Supplementary RR (SRR) to complete an internal RR2. The points for internal matches in RR1, added to the points scored in Second RR, give the RR2 scoring.
- (b) The four highest scored skippers in RR2 will qualify for the semi finals.
- (c) For the skippers placed fifth and sixth in RR2 the places are final.

B3. SEMI-FINALS

- (a) Skippers will be paired in accordance with the attached table.
- (b) The first skipper to score at least two (2) points shall proceed to the next round.

B4. FINALS

- (a) Skippers will be paired in accordance with the attached table.
- (b) The first skipper to score at least two (2) points shall be the winner; the other shall be awarded the second place.

B5. Third/Fourth Place Final

- (a) Skippers will be paired in accordance with the attached table.
- (b) The first skipper to score at least two (2) points shall be awarded the third place, the other fourth place.

B6. Places seven to twelve

- (a) The remaining skippers will be paired to sail one match to determine their final positions. Those placed fourth sail for places seven and eight, those places fifth for places nine and ten, and those placed sixth for places eleven and twelve.

SCHEDULE OF RACES

RR 1 Group A	Match 1	Match 2	Match 3
Flight 1	A5 - A3	A1 - A6	A4 - A2
Flight 2	A3 - A1	A5 - A2	A6 - A4
Flight 3	A1 - A5	A4 - A3	A2 - A6
Flight 4	A6 - A5	A3 - A2	A4 - A1
Flight 5	A6 - A3	A5 - A4	A2 - A1

RR 1 Group B	Match 1	Match 2	Match 3
Flight 1	B5 - B3	B1 - B6	B4 - B2
Flight 2	B3 - B1	B5 - B2	B6 - B4
Flight 3	B1 - B5	B4 - B3	B2 - B6
Flight 4	B6 - B5	B3 - B2	B4 - B1
Flight 5	B6 - B3	B5 - B4	B2 - B1

SRR (RR 2)	Match 1	Match 2	Match 3
Flight 1	B2 - A1	A3 - B1	B3 - A2
Flight 2	A3 - B2	A2 - B1	A1 - B3
Flight 3	B3 - A3	B2 - A2	B1 - A1

A1= Winner in Group A

A2= Second in Group A

A3= Third in Group A

B1= Winner in Group B

B2= Second in Group B

B3= Third in Group B

SF + 7, 8, 9, 10	Semi Final 1	Semi Final 2	Match 3
Flight 1	RR24 - RR21	RR23 - RR22	B4 - A4
Flight 2	RR21 - RR24	RR22 - RR23	B5 - A5
Flight 3	RR24 - RR21	RR23 - RR22	

RR2.1= First in RR2

RR2.2= Second in RR2

RR2.3= Third in RR2

RR2.4= Fourth in RR2

A4= Fourth in Group A

A5= Fifth in Group A

B4= Fourth in Group B

B5= Fifth in Group B

Finals + 11, 12	Match 1 (3/4)	Final	Match 3
Flight 1	LSF - LSF	WSF - WSF	B6 - A6
Flight 2	LSF - LSF	WSF - WSF	
Flight 3	LSF - LSF	WSF - WSF	

A6= Sixth in Group A

B6= Sixth in Group B

M.6 Tie Break Sail Offs

When a sail off is required to break a tie the following system will resolve the tie with the minimum number of matches and avoid the possibility of further ties.

‘A v B > winner (loser) D’ means that A sails against B and the winner (loser) is designated D.

Port and Starboard assignments are initially random dependant on the draw. Later assignments redress some of the imbalance in the initial draw.

3 Tied Boats - 1 to go through to the next round (or to determine event winner)

The 3 tied boats draw lots A, B & C.
A v B > winner D – loser goes out
C v D > winner goes through – loser goes out

3 Tied Boats - 2 to go through to the next round

The 3 tied boats draw lots A, B & C.
A v B > loser D - winner goes through
D v C > winner goes through – loser goes out.

5 Tied Boats – 1 to go through to the next round (or to determine the event winner)

In every case, the 5 tied boats draw lots for A, B, C, D & E.
A v B > winner F – loser goes out
C v D > winner G – loser goes out
E v F > winner H – loser goes out
H v G > winner goes through – loser goes out

5 Tied Boats – 2 to go through to the next round

A v B > winner F – loser goes out
C v D > winner G – loser goes out
E v F > loser H – winner goes through
H v G > winner goes through – loser goes out

5 Tied Boats – 3 to go through to the next round

A v B > loser F – winner goes through
C v D > loser G – winner goes through
E v F > winner H – loser goes out
G v H > winner goes through – loser goes out

5 Tied Boats – 4 to go through to the next round

A v B > loser F – winner goes through
C v D > loser G – winner goes through
F v E > loser H – winner goes through
H v G > winner goes through – loser goes out



INTERNATIONAL UMPIRES' AND MATCH RACING MANUAL

SECTION N

Umpires Programme

Contents		Page
N	Umpires Programme	
N.1	The Origin of the Umpires Programme	N 2
N.2	The Goals of the Programme	N 2
N.3	How to Achieve These Goals	N 3
N.4	Performance Assessment	N 3
N.5	The Grouping System	N 4
N.6	How to Contribute to the Umpires Programme	N 4
N.7	International Umpires Sub-committee	N 5
N.8	International Umpires Administration	N 5
	ISAF Umpire Performance Assessment Form	N 6

N.1 The Origin of the Umpires Programme

The first ISAF umpiring seminars were held in 1989, and the first International Umpires were appointed in 1990. These two dates effectively mark the beginning of the ISAF Umpiring Programme.

In 1995 the International Judges Subcommittee was split into two subcommittees: one for International Judges and one for International Umpires, both now residing under the Race Officials Committee rather than the Racing Rules Committee

N.2 The Goals of the Programme

The aims of the International Umpires Subcommittee (IUSC) are outlined in its Terms of Reference (which can be found on the ISAF website). One of these aims is to administer the International Umpires Programme. This programme is further defined in ISAF Regulation 6.9.9.

Some goals of the umpires programme are:

- i) To conduct umpire seminars

aim: to continue to train Umpires around the world at the same pace as the worldwide development of match and team racing.

To do this consistently and to the appropriate level the programme needs qualified instructors who are able to give enough time to the sport to keep their training and their own umpiring up to date. They are also instrumental in the development of the seminar programmes.

- ii) To develop training and testing materials for seminars

aim: to ensure worldwide consistency in training and testing.

To do this each instructor needs to have the same training tools and all umpires need to be tested at the same level and on the same skills and attributes.

- iii) To train instructors

aim: to expand the instructors' network without compromising on quality or consistency.

To do this the instructors need instruction as a group, ensuring that they will deliver the same materials the same way.

- iv) Assist Member National Authorities in training and developing National Umpiring Programmes

aim: to meet the needs of MNA's wishing to set up national umpiring programmes and to encourage MNA's to develop match and team racing.

To promote further development of umpiring and match and team racing on a national level a package is being developed which MNA's can use as a starter kit to set up their own programmes. Such an ISAF-developed start-up scheme will help to ensure consistency.

N.3 How To Achieve These Goals

To this end the IU seminars intended to qualify delegates as International Umpires have been held for many years now. A new activity is the development of match racing/umpiring clinics where sailors, umpires and race committees alike are introduced to the sport of match racing.

These clinics are targeted at groups of countries with no or very little match racing, with the aim of making match racing and umpiring more popular. Not only does the ISAF instructor deliver a week of introductory match racing and umpiring drills, but he/she also aims to leave behind enough enthusiasm and interest for the MNA's in that area to continue a programme after the clinic is over. Good documentation and long-term follow-up are essential.

This initiative is instrumental to ensure that the gap between those countries that have a match racing programme and those that do not is diminished.

N.4 Performance Assessment

Consistency is probably the key word of the entire Umpiring Programme. This does not only apply to rulings on the water ('umpires' calls') but equally to temperament and behaviour.

These days we start most seminars by asking the delegates what qualities they think make a good umpire ('how would you recognize a good umpire if you saw one?'). The skills and attributes that delegates tend to come up with will contain a number of technical skills (rules application, boat positioning, etc.). However, the list of 'people skills' will invariably be longer.

These lists have been combined in a document now known as the 'ISAF Umpire Performance Assessment Form' (attached at the end of this Part). This form contains the guidelines and criteria by which the IU seminar instructors assess delegates on the water and ashore.

It is important for both qualified IU's and new umpires to know by which criteria they are being assessed, whether it is by the instructor, the IUSC or the umpire's colleagues during an event. They may also be useful for the umpire himself to check and grade his own performance on a regular basis!

By pointing out to a trainee umpire that when situation ABC occurred, this displayed a strength or weakness in area XYZ of the trainee's skills, the instructor is able to give useful and objective feedback that should help the trainee improve his skills.

These Assessment Guidelines are also used by the IUSC when the applications for IU status are discussed each November.

Finally, they are meant to be a useful tool for umpires filling out the comments section of their Umpire Event Report Forms at the end of each regatta. This confidential information is again used by the IUSC when it comes to (re-) certifying umpires as IU's.

The aim of this system is to establish a fair, objective and consistent method for assessing performance and it is hoped that all umpires will help to develop it further.

N.5 The Time of the Misdeed

The grouping system divides international umpires into groups that reflect their competence in top-level match racing events. The system was introduced to facilitate the process of selecting appropriate umpire teams for the events that ISAF appoints umpires to (listed in regulation 6.9.9.3(i)) and to provide a basis for developing individual international umpires.

The system is administered by the IUSC. It was designed in 2003 and first used in the winter 2003/2004 to select the core of umpire teams for the top-level match racing events in 2004. Based on these experiences, the system was redesigned. The process of assigning the international umpires to groups is conducted by a grouping panel. This panel consists of about 10 members that are all international umpires.

Currently, the grouped umpires are divided into two groups with these definitions:

- Group 1: An IU that is deemed capable of umpiring any match at a Grade 1 event, even alongside an umpire of a lower standard. It is accepted that a Group 1 IU makes consistently good decisions and has no problems with any of the overall criteria on the ISAF Umpire Performance Assessment Form.
- Group 2: An IU with the potential to be a Group 1 umpire but needs more experience, or an IU who consistently performs below the level that is required of a Group 1 umpire. A Group 2 umpire may have minor problems with one or more of the overall criteria on the ISAF Umpire Performance Assessment Form but no major problems with any criterion.
- Group 2 is divided into the following three sub-groups:
 - 2a: High-standard IU who has minor problems with one or two overall performance criteria and therefore performs just below the standard of a Group 1 umpire.
 - 2b A solid IU who has minor problems with more than two overall performance criteria and therefore performs consistently below the level that is required of a Group 1 umpire.
 - 2c: Weaker IU who has minor problems with several of the overall performance criteria and therefore performs just to the standard required by an IU.

The grouping is only made for umpires who apply to be grouped. Thus an IU can decide to remain ungrouped.

N.6 How To Contribute To The Umpires Programme

While the ISAF has made the training of officials one of its key responsibilities, it is very much the umpires themselves who determine whether the umpires programme will be successful in expanding and improving.

Each umpire has something to contribute to the programme, whether it is the write-up of an interesting call, a new idea on communication techniques, boat positioning, or a suggested improvement of this Manual. Constructive criticism by delegates continues to help improve the set-up of seminars.

It is the IUSC's aim to make every umpire part of the team that helps to build the programme. The sport of match racing continues to develop so fast that we constantly need

to upgrade our skills, our methods of training and testing ourselves, and also our way of communicating with each other during the year in order to maximize the benefit from each other's experience.

If you have any suggestions, criticism, or experience that you feel might benefit any part of the umpires programme, please send them to the ISAF Office to the attention of the IUSC.

N.7 International Umpires Sub-committee

The Terms of Reference for the International Umpires Sub-committee is contained in ISAF Regulation 6.9.9.

N.8 International Umpires Administration

The International Umpires Administration is contained in ISAF Regulation 31, in particular 31.4 to 31.10, 31.12 and 31.15 to 31.23.

ISAF Umpires Performance Assessment Form

Seminar/Event:	Dates:			
Candidate's Name:	Nationality:			
E-mail:				
A. Observation	----- <input type="checkbox"/> IU standard	----- <input type="checkbox"/> Not yet IU standard	----- <input type="checkbox"/> NU standard	----- <input type="checkbox"/> Don't know
B. Communication	----- <input type="checkbox"/> IU standard	----- <input type="checkbox"/> Not yet IU standard	----- <input type="checkbox"/> NU standard	----- <input type="checkbox"/> Don't know
C. Rules: Application and Decisions	----- <input type="checkbox"/> IU standard	----- <input type="checkbox"/> Not yet IU standard	----- <input type="checkbox"/> NU standard	----- <input type="checkbox"/> Don't know
D. Boat Driving and Positioning	----- <input type="checkbox"/> IU standard	----- <input type="checkbox"/> Not yet IU standard	----- <input type="checkbox"/> NU standard	----- <input type="checkbox"/> Don't know
E. Procedures	----- <input type="checkbox"/> IU standard	----- <input type="checkbox"/> Not yet IU standard	----- <input type="checkbox"/> NU standard	----- <input type="checkbox"/> Don't know
F. Temperament and Behaviour	----- <input type="checkbox"/> IU standard	----- <input type="checkbox"/> Not yet IU standard	----- <input type="checkbox"/> NU standard	----- <input type="checkbox"/> Don't know
G. Physical Fitness	----- <input type="checkbox"/> IU standard	----- <input type="checkbox"/> Not yet IU standard	----- <input type="checkbox"/> NU standard	----- <input type="checkbox"/> Don't know
H. Experience and Activity	----- <input type="checkbox"/> IU standard	----- <input type="checkbox"/> Not yet IU standard	----- <input type="checkbox"/> NU standard	----- <input type="checkbox"/> Don't know
Other comments				
Overall Assessment	----- <input type="checkbox"/> IU standard	----- <input type="checkbox"/> Not yet IU standard	----- <input type="checkbox"/> NU standard	----- <input type="checkbox"/> Don't know
	Candidate should be encouraged to apply for IU status		<input type="checkbox"/>	Yes
			<input type="checkbox"/>	Not yet (encouraging)
			<input type="checkbox"/>	No
	Candidate needs another performance assessment		<input type="checkbox"/>	No
			<input type="checkbox"/>	Yes
Instructor or Assessor	Name:	Signature:	Date:	
With my signature I confirm that I have shared this assessment with the candidate				

*For each overall category mark either on the dashed line (continuum) or in one of the three boxes.
Write Comments / Needs for improvement / Special strengths for each overall category (refer to detailed criteria).*

IU Standard	You have evidence that the candidate meets the criteria listed below. Add your observations about special strengths and particular areas where the candidate would benefit from improvement.
Dashed Line (continuum) or NU standard	You have evidence that the candidate does not meet some of the criteria listed below. Record this on the form with a mark below (to the right of) the “IU standard” box. You can use the dashed line (continuum) to mark how close to or far away from IU standard the candidate’s performance is. The mark can be a range. Such a mark in any category means that the candidate is not yet on IU level, and the IUSC is unlikely to recommend that this candidate be appointed as IU.
Don't Know	You have insufficient evidence to form a considered judgement. This may happen when the number of matches is insufficient or the matches observed do not have enough incidents. You should still provide any observations about the candidate’s performance.
Note	All marks, comments and suggestions <u>must</u> be shared with the candidate before the form is submitted. For all comments and suggestions, refer to the detailed criteria below. The two questions under Overall Assessment must be answered.

Performance Assessment Criteria:

A. Observation	Identifies own boat 95% of the time. Spots competitor activities: Y-flags, red flags, breakdowns and penalties taken. Observes relevant race committee actions: start sequence, recalls, course changes. Concentrates on own issue, avoiding other issues when these are distracting. Observes other matches and reacts when other umpires need assistance. Is able to clearly describe an incident after the match, both afloat and ashore.
B. Communication	Is able to communicate in English and uses standard umpire terminology. Speaks and understands English at umpire speed. Listens to and takes account of fellow umpire’s opinions and observations. Gives and receives proper wing boat calls. Is able to communicate clearly and calmly with fellow umpires, competitors and organisers. Speaks the key facts and rule transitions concisely as they occur. Communicates decisions and reasons, only stating facts/rights/obligations when relevant. Predicts standard match /team racing manoeuvres and states most likely option 80% of the time.
C. Rules: Application and Decisions	Clear understanding of definitions affecting on-the-water rules. Identifies right of way boat and basic obligations and opportunities 95% of the time. Recognises and applies the principles of rule 15 and 16. Identifies when rule 17 applies and interprets proper course correctly. Is able to call incidents at marks correctly and recognizes when rule 18 turns on and off. Identifies obstructions when relevant and when these rules come into force. Understands and correctly implements umpire-initiated, red-flag, double and twin penalties. Applies rules, cases and calls correctly. Makes consistent decisions. Is able to call and process multiple incidents occurring in rapid succession. Demonstrates knowledge of rules, cases and calls on the water, in discussions and debriefings
D. Boat Driving and Positioning	Is able to operate small powerboats. First preparation, leaving/returning to mooring/dock, going to and returning from the course safely, transferring personnel safely. Minimum rushing around so that passengers are never at risk. Is able to follow the basic position plan, modifying when appropriate. Correct distance from and angle to race boats 90% of the time. Smooth transition between scenarios. Rapid response when out of position. Low level of interference with any match and no unnecessary wash. Anticipates possible manoeuvres and drives proactively (not reactively)

E. Procedures	<p>Complies with ISAF code of conduct. Is well prepared both ashore and afloat. Handles competitor-initiated and umpire-initiated penalties correctly. Proper use of radio, including procedures and response to calls. Understands protest committee procedures. No unauthorised communication with the media.</p>
F. Temperament and Behaviour	<p>Accepts ISAF rules, cases and calls. Team player, pulls own weight within the team and works well with others. Helps less competent umpires positively both afloat and ashore. Is able to maintain good relations with umpires, organisers and race committee. No prejudice to any competitors, either negative or positive. Handles post-race de-briefings in a manner that encourages learning and improvement. Works well under pressure and is able to make and signal timely, accurate decisions. Is willing to learn and accepts comments/advice from others. Accepts change and has a positive attitude to suggestions from others. Keeps to time. Has respect for other people's property and treats accordingly. No alcohol until the work of the day is done. Responds in a timely manner to pre- and post-event communication.</p>
G. Physical Fitness	<p>Is able to spend long days on the water in small boats in bad conditions and maintain focus. Mobility adequate for transferring between small boats afloat in moderate conditions and able to stand in good position to umpire. Hearing, eyesight and voice adequate to function as an umpire. Is able to participate and contribute in meetings and debriefings after long days on the water.</p>
H. Experience and Activity	<p><i>These criteria are primarily for assessment of existing IUs</i> Has umpired at high-level events. Is familiar with the types of boats that are typically used for match or team racing. Is umpiring at an adequate number and appropriate level of events every year. Has experience as a chief umpire or “lead” umpire.</p>



INTERNATIONAL UMPIRES' AND MATCH RACING MANUAL

SECTION O

Reserved for Future Use



INTERNATIONAL UMPIRES' AND MATCH RACING MANUAL

SECTION P

List of Forms

Contents

Page

List of Forms

P.1	International Umpires Sub-committee Forms	P 2
P.2	Match Racing Committee Forms	P 2

The forms listed can all be found at the ISAF website, under Race Officials; International Umpire, and Documents Library. The Documents Library is meant to be a place where you can always go to find any documents you may need as an umpires – whether before an event, at an event or after an event. Proposals for documents that should be included in the library are most welcome.

International Umpires Sub Committee Forms

IU Application Form

This is an online application system and applications are to be completed by applicants for IU status, either first time applications or renewals. First time applications must be submitted through the applicants MNA.

IU Reference Form

Completed by the chief umpire at an event, to record the performance of a prospective IU upon their request.

IU Assessment Form and Assessors guidelines

Completed by ISAF IU Assessors, to record the performance of an individual IU or prospective IU, mainly at IU seminars but also at events on request.

IU Event Report Form

Completed for both team and match racing events, and submitted to ISAF to record event statistics, highlights from the event and umpire performance.

Match Race Committee Forms

ISAF Match Racing Grading and Report Form

Completed by the event organiser, and submitted through the MNA to ISAF in order for ISAF to allocate a provisional event grading. (As contained in the NoR.)

Completed and sent to ISAF by the Chief Umpire immediately after the event to confirm actual event information in order for ISAF to confirm the event grading and enter the results into the competitor ranking system

The criteria for Grading Events and the system for ranking competitors can also be found on the ISAF website.



INTERNATIONAL UMPIRES' AND MATCH RACING MANUAL

SECTION Q

Contents

Page

- Q.1 Addendum Q – Umpired Medal Race Rules
- Q.2 Appendix Q – Umpired Fleet Racing Rules

Q 2
Q 2

Q.1 Addendum Q – Umpired Medal Race Rules

Addendum Q is a set of sailing instructions specifically designed for events using medal races. These rules have now been used for several years, including at the 2012 London Olympics. The current version is available on the ISAF website, together with supporting documents for sailors, umpires and organizers. The addendum is not a part of the Racing Rules of Sailing, however, under rule 86.2 and Regulation 28.1.3, the ISAF has approved the use of these sailing instructions as an addendum to the sailing instructions as specified in the preamble to the addendum.

Races may be sailed under the sailing instructions in this addendum only if the notice of race so states and the addendum is included in the sailing instructions.

Use of this addendum is recommended for races in which about ten one-design boats compete with umpires present. There should be one umpire boat for every three or four boats in the fleet.

Q.2 Appendix Q – Umpired Fleet Racing Rules

Appendix Q is an experimental set of rules and it sets a standard for umpired fleet racing. It is not a part of the Racing Rules of Sailing, however, ISAF has published this Appendix in order that organisers planning on using direct judging of fleet races in fleets of about 30 boats can test these rules.

The Appendix can be found in the Umpires Library at ISAF's website, under Race Officials.

The Appendix also contains questionnaires for umpires, chief umpires and competitors and information on these will be of great importance for the work on preparing a submission for the next rule book.